

07/2022

K 07/22/1
Gruppe 1

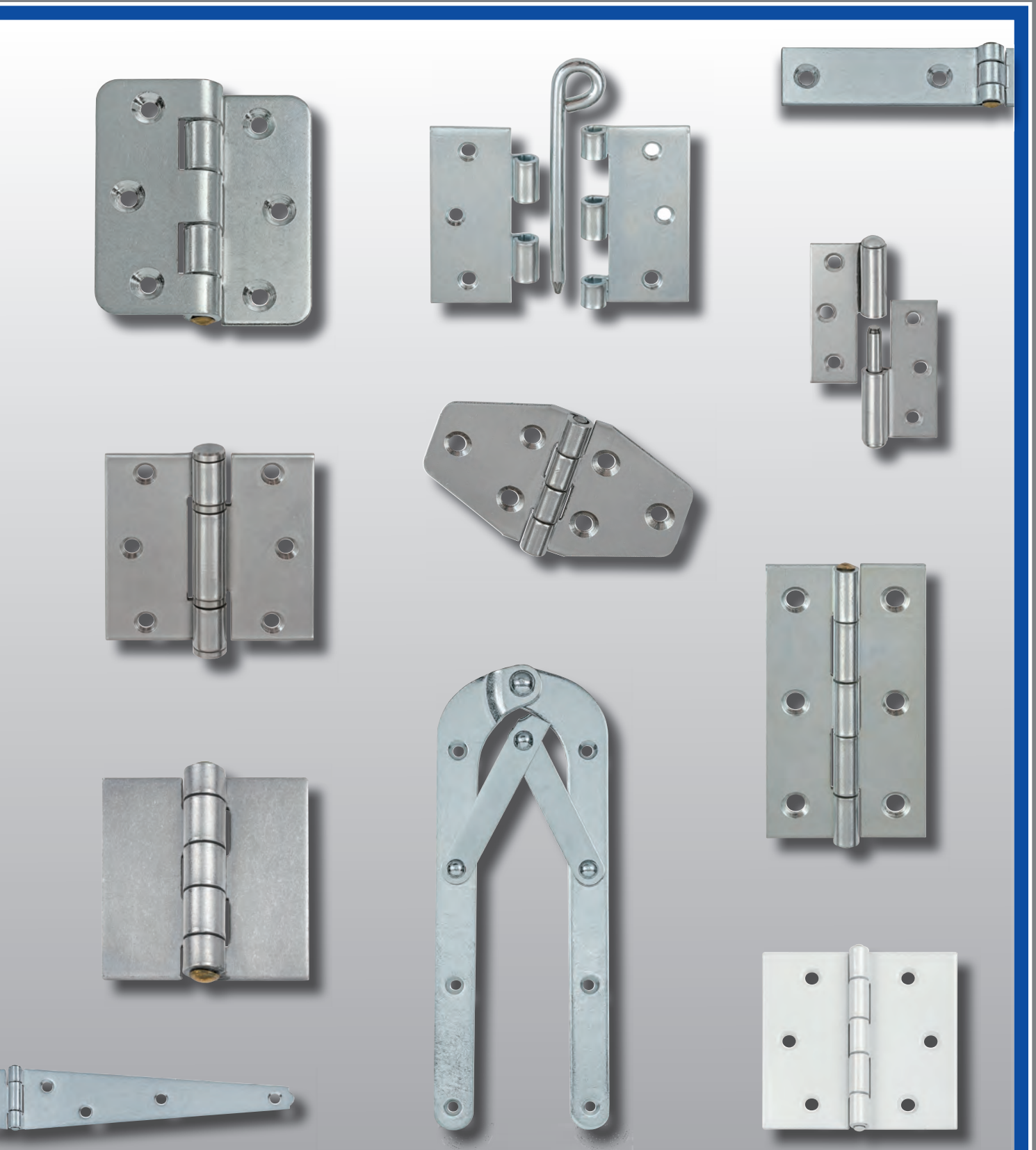



Heilenbecker Straße 191-205,
58256 Ennepetal
Hauptverwaltung



Weichselstraße 9-11, 58256 Ennepetal
Logistikzentrum



Berliner Straße 50, 04910 Elsterwerda
Werk Elsterwerda



George/Südafrika
Vertriebsniederlassung Südafrika



VORMANN beschäftigt an seinen 3 deutschen Standorten etwa 190 Mitarbeiter. Das in der 5. Generation inhabergeführte Familienunternehmen bietet neben der Produktion und dem Vertrieb von Standardsortimenten im Bereich Verbindungselemente auch die Konzeption und Herstellung von Sonderanfertigungen an. VORMANN setzt bei der Produktion auf das Gütesiegel „Made in Germany“. Mit dem Erwerb der CE-Kennzeichnung für seine statisch relevanten Holzverbinder und Stützenschuhe bietet VORMANN mehr Transparenz im Hinblick auf Produktsicherheit und -qualität. Das schon vor Jahren eingeführte Qualitätsmanagement nach DIN EN ISO 9001:2015 mit regelmäßigen Auditierungen und Überprüfungen sorgt für gleichbleibende Qualität. Mit Gründung einer eigenen Vertriebsgesellschaft in George/Südafrika zur Jahrtausendwende gelingt VORMANN der Eintritt in einen neuen Markt.



VORMANN employs roughly 190 associates at its 3 German facilities. The family-owned company, now managed by its owners in the 5th generation offers not only the production and sale of standard ranges in the area of fasteners but also the conception and production of custom-made products. In manufacturing VORMANN relies on the „Made in Germany“ quality seal. With the acquisition of the CE marking for its statically relevant timber connectors and supporting shoes, VORMANN offers more transparency with regard to product safety and quality. The quality management system according to DIN EN ISO 9001: 2015 with regular audits and inspections provides consistent quality. With the establishment of its own sales subsidiary in George/South Africa at the turn of the millennium, VORMANN successfully takes the first step into a previously little-known market.



VORMANN emploie quelque 190 personnes réparties sur un total de trois sites allemands. Parallèlement à la production et à la distribution de produits standard dans le domaine des éléments de fixation le entreprise familiale dirigée par ses propriétaires depuis cinq générations conçoit et fabrique également sur plan des produits sur mesure. Les produits VORMANN répondent au label de qualité « Made in Germany ». L'obtention du marquage CE pour ses raccords pour constructions en bois et ses supports d'ancrage aux propriétés statiques permet par ailleurs à VORMANN d'offrir une plus grande transparence concernant la qualité et la sécurité des produits. Nos processus de gestion de la qualité conformes à la norme DIN EN ISO 9001:2015, qui sont mis en œuvre depuis déjà de nombreuses années et incluent des audits et contrôles réguliers et garantissent une qualité constante. Avec la fondation de sa propre agence commerciale à George/Afrique du Sud au tournant du millénaire, VORMANN fait ainsi ses premiers pas sur un marché jusque-là peu connu.



VORMANN cuenta en sus 3 emplazamientos alemanas por unos 190 empleados. Esta empresa familiar, que ya se encuentra en su quinta generación ofrece además de la producción y venta de productos estándar en el área de los elementos de unión la concepción y fabricación de producciones especiales. VORMANN apuesta en su producción por el sello de calidad „Made in Germany“. Con la adquisición de el distintivo CE para sus uniones para madera y apoyos de importancia estática, VORMANN ofrecer más transparencia tanto lo que respecta a la seguridad y calidad de sus productos. El sistema de gestión de calidad introducido ya hace años conforme a la norma DIN EN ISO 9001:2015, con auditorías y controles periódicos, garantiza una calidad constante. Con el establecimiento de su propia filial de ventas en George/Sudáfrica a comienzos del milenio, VORMANN consigue con éxito adentrarse en un mercado hasta entonces poco conocido.



Inhaltsverzeichnis

List of contents
Table de matières
Términos técnicos

Seite
page
page
página



32-36	Anschweißbänder	Weld-on hinges
28	Aufschraubbänder	Screw-on-hinges
28, 29	Aushebescharniere	Lift-off hinges
36	Bolzgelenkbänder	Bar joint hinges
10-12, 15, 32	DIN-Scharniere	DIN hinges
11	DIN-Scharniere für die Industrie	DIN hinges for industry
13, 18-21, 25, 27-28, 32-35	Edelstahl-Scharniere	Stainless steel hinges
29	Fensterscharniere	Window hinges
20	Franz. Kistenbänder	French case hinges
20	Kistenbänder	Case hinges
29	Klappenscharniere	Flap hinges
24	Kulissenscharniere	Scenery hinges
29	Kunststoffscharniere	Plastic hinges
26	Lamellentürscharniere	Lamella-door hinges
30	Leiterbänder	Ladder hinges
14	Messingscharniere	Brass hinges
26, 27	Möbelscharniere	Furniture hinges
36	Nietgelenkbänder	Rivet joint hinges
27	Normenscharniere	Standard hinges
26	Paraventscharniere	Screen hinges
29	Pendeltürbänder	Swing door hinges
36	Profilbänder	Profile hinges
27	Reparaturbänder	Repair strips
16, 17	Scharnierbänder	Strap hinges
26	Schatullenscharniere	Casket hinges
17	Schlosserscharniere	Locksmith hinges
30	Schulwandtafelscharniere	Blackboard hinges
24-30	Spezialscharniere	Special hinges
34	Stahlfensterscharniere	Steel window frame hinges
25, 35	Stangenscharniere	Piano hinges
16-19	Starke Scharniere	Strong hinges
20	T-Bänder	T-shaped hinges
12, 13, 15, 16, 17, 33	Tischbänder	Flap hinges
27, 28	Türscharniere	Door hinges
32-36	Ungebohrte Scharniere	Undrilled hinges
29	Verbundfensterscharniere	Composite window hinges
36	Wagentürscharniere	Car door hinges

Technische und geschmackliche
Änderungen vorbehalten.

We reserve the right to make alterations
of a technical nature and concerning
appearance.



F



E

Seite
page
page
página

Pentures à souder	Bisagras para soldar	32-36
Paumelles à visser	Bisagras para atornillar	28
Charnières dégonnables	Bisagras extraíbles	28, 29
Charnières à broche	Bisagras articulado con perno	36
Charnières DIN	Bisagras DIN	10-12, 15, 32
Charnières DIN pour l'industrie	Bisagras DIN para la industria	11
Charnières en acier inoxydable	Bisagras de acero inoxidable	13, 18-21, 25, 27-28, 32-35
Charnières de fenêtre	Bisagras para ventanas	29
Pentures de coffres françaises	Bisagras francesas para cajas	20
Pentures de coffres	Bisagras para cajas	20
Charnières d'abattant	Bisagras para fijación de puertas abatibles	29
Charnières à broche amovible	Bisagras de corredera	24
Charnières en plastique	Bisagras de plástico	29
Charnières de portes à lamelle	Bisagras de puerta Louvre	26
Charnières d'échelle	Bisagras para escaleras curvadas	30
Charnières en laiton	Bisagras de latón	14
Charnières de meubles	Bisagras para muebles	26, 27
Charnières rivées	Bisagras de remache articuladas	36
Charnières standard	Bisagras estándar	27
Charnières de paravents	Bisagras para biombos	26
Paumelles de portes va-et-vient	Pernios para puertas de vaivén	29
Paumelles profilées	Bisagras de perfil	36
Paumelles de secours	Pernios de reparación	27
Bandes à charnière	Bisagras	16, 17
Charnières coffret	Bisagras para cofres	26
Charnières de serrurier	Bisagras de cerrajero	17
Charnières de tableaux noir	Bisagras para pizarras	30
Charnières spéciales	Bisagras especiales	24-30
Charnières pour fenêtres en acier	Bisagras para ventanass métálicas	34
Charnières à piano	Bisagras corridas tipo piano	25, 35
Charnières fortes	Bisagras fuertes	16-19
Pentures anglaise	Bisagras de ramal en T	20
Charnières de table	Bisagras alargadas	12, 13, 15, 16, 17, 33
Charnières de porte	Bisagras de puerta	27, 28
Charnières non alésées	Bisagras sin taladrar	32-36
Charnières de fenêtres à survitrages	Bisagras ventanas de contravidriera	29
Charnières de portières de voitures	Bisagras para puertas de coche	36



Technische Angaben

Technical terms
Termes techniques
Términos técnicos



D



GB



F



E

gerollt	rolled	enroulé	arrollado
geschlagen	folded	plié	plegado
leicht	light	léger	ligero
schwer	heavy	lourd	pesado
schmal	narrow	étroit	estrecho
halbbreit	semi-wide	mi-large	semi-ancho
käntig (kantig/quadratisch)	square	carré	cuadrado
breit	wide	large	ancho
gerade	straight	droit	recto
gekröpft	cranked	coudé	acodado
aushebbar	lift-off design	amovible	extraíble
rechts/links	right/left	droite/gauche	derecha/izquierda
mit vernietetem Eisenstift	with riveted iron pin	avec goupille rivetée en fer	con pasador de hierro remachado
mit vernietetem Messingstift	with riveted brass pin	avec goupille rivetée en laiton	con pasador de latón remachado
mit vernietetem Edelstahlstift	with riveted stainless steel pin	avec goupille rivetée en acier inoxydable	con pasador de acero inoxidable remachado
mit loseem Eisenstift	with loose iron pin	avec goupille en fer non fixée	con pasador de hierro suelto
mit loseem Messing-Knopfstift	with loose brass button pin	avec goupille à tête en laiton non fixée	con pasador redondeado de latón suelto
mit loseem Edelstahl-Knopfstift	with loose stainless steel pin	avec goupille à tête en acier inoxydable non fixée	con pasador de acero inoxidable suelto
mit aushebbarem Ringstift	with lift-off ring pin	avec goupille à anneau amovible	con pasador anular extraíble
mit Edelstahl-Zylinderstift	with stainless steel cylinder pin	avec goupille cylindrique en acier inoxydable	con pasador cilíndrico inoxidable
mit Edelstahl Zwischenringen	with stainless steel intermediate rings	avec anneaux intermédiaires en acier inoxydable	con anillos intermedios de acero inoxidable
mit Kunststoff-Zwischenringen	with plastic intermediate rings	avec anneaux intermédiaires en plastique	con anillos intermedios de plástico
mit durchgedrücktem Gewerbe	with swaged joint	avec charnière encastrée enfoncée	con bote acodado
mit abgerundeten Ecken	with rounded corners	avec coins arrondis	con esquinas redondeadas
mit Nagellöchern	with nail holes	avec trous de clous	con agujeros para clavos
mit Schraublöchern	with screw holes	avec trous de vis	con agujeros para tornillos
mit versenkten Schraublöchern	with countersunk screw holes	avec trous de vis fraisés	con agujeros embutidos para tornillos
mit Spiralfeder	with spiral spring	avec ressort en spirale	con resorte espiral
mit Axialspiel	with axial play	avec jeu axial	con juego axial
ohne Axialspiel	without axial play	sans jeu axial	sin juego axial

Technische Angaben

Artikel-Nr.	GTIN 4003984	Abmessungen mm			ca. kg je VE	Schrauben		verp. zu... Stck.
		A	B	Stärke		Stck.	Ø mm	

Technical terms

Item number	GTIN 4003984	Dimensions mm			approx. kgs p. pu	screws		Packed as... pcs.
		A	B	thick- ness		pcs.	Ø mm	

termes techniques

Code Article	GTIN 4003984	Dimensions en mm			env. kg p. paq.	viss		emballé à... pcs.
		A	B	épais- seur		psc.	Ø mm	

Términos técnicos

Número de artículo	GTIN 4003984	Dimensiones mm			approx. kgs. p. paq.	viss		empa- queta- das en... pza.
		A	B	Espesor		Espesor	Ø mm	



B	braun
BG	Bolzengelenkband
EK	eiserner Knopfstift
MK	Messing-Knopfstift
N	vernickelt
NM	matt vernickelt
NG	Nietgelenkband
PS	Polyamid schwarz
P	poliert
RI	mit Ringstift Eisen blank
S	schwarz
U	ungebohrt Eisen blank
V	vermessingt
VE	vernieteter Eisenstift
VM	vernieteter Messingstift
W	weiß
Z	verzinkt
ZL	verzinkt lose (Großverpackung)
ZR	mit Ringstift verzinkt

 Edelstahl Rostfrei
V2A

MESSING

Messing



brown
Bar joint hinges
iron button pin
brass button pin
nickel-plated
nickel-plated matt finish
rivet joint hinge
polyamid black
polished
with ring pin iron uncoated
black
undrilled iron uncoated
brass-plated
riveted iron pin
riveted brass pin
white
galvanized
galvanized (bulk pack)
with ring pin galvanized

 stainless steel
V2A

MESSING

brass



brun
Charnières à broche
goupille à tête en fer
goupille à tête en laiton
nickelé
nickelé mat
charnière rivetée
polyamide noir
poli
avec goupille à anneau fer brut
noir
non alésé fer brut
laitonné
goupille rivetée en fer
goupille rivetée en laiton
blanc
galvanisé
galvanisé en vrac
avec goupille à anneau galvanisé

 acier inoxydable
V2A

MESSING

laiton



marrón
Bisagra articulada con perno
pasador redondeado de hierro
pasador redondeado de latón
niquelado
niquelado mate
pernio articulado para remacher
poliamida negra
pulido
con pasador anular hierro bruto
negro
sin taladrar hierro brillante
latonado
pasador de hierro remachado
pasador de latón remachado
blanco
galvanizadas
galvanizadas a granel
con pasador anular galvanizado

 acero inoxidable
V2A

MESSING

latón

Numerisches Inhaltsverzeichnis

Numerical table of contents
Table des matières numérique
Índice numérico

Bestell-Nr.: order no. no. de commande número de pedido	Seite page page pagina	Bestell-Nr.: order no. no. de commande número de pedido	Seite page page pagina	Bestell-Nr.: order no. no. de commande número de pedido	Seite page page pagina	Bestell-Nr.: order no. no. de commande número de pedido	Seite page page pagina
000003	17	000612	19	020501-020503	14	092460	27
000004	17	000613	18	020694	26		
000005	17	000614	19, 24, 35	090850	10		
000007	16	000620, 000621	27	090851	10		
000010	17	000623	26	090852	10		
000012	36	000632	29	090858	26		
000013	29	000650	34	090859	26		
000014	36	000653	34	090861	26		
000019	30	000701-000705	15	090862	26		
000028	20	000706	16	090870	14		
000029	29	000850	29	090871	14		
000030	18	000855	28	092028	13		
000032, 000033	30	000861	28	092029	13		
000042	20	010028	20	092030	13		
000044	20	010043	21	092033	13		
000047	16	010046	21	092050	10		
000048	18	010096	20	092051	10		
000056-000059	24	010450	25	092055	10		
000096	20	010460	25	092056	10		
000217	20, 33	010501-010505	13, 32, 33	092057	10		
000401-000405	11, 12, 32, 33	010613	18, 34	092058	10		
000440	29	010614	19, 35	092061	14		
000445	29	010617	19	092078	10		
000450	25	010620	27	092079	10		
000460	25	010870	28, 35	092080	10		
000501-000505	10, 12	010871	28	092087	16		
000506	16, 33	010872	28	092096	27		
000611	18	011001	35	092097	27		



Standardscharniere

Standard hinges
Charnières standards
Bisagras estándar

Seite
page
page
página



10, 12, 15	DIN-Scharniere	DIN hinges
11	DIN-Scharniere für die Industrie	DIN hinges for industry
13, 18-21	Edelstahl-Scharniere	Stainless steel hinges
20	Franz. Kistenbänder	French case hinges
20	Kistenbänder	Case hinges
14	Messingscharniere	Brass hinges
16, 17	Scharnierbänder	Strap hinges
17	Schlosserscharniere	Locksmith hinges
18-19	Starke Scharniere	Strong hinges
20	T-Bänder	T-shaped hinges
16-17	Tischbänder	Flap hinges

**F****E**Seite
page
page
página

Charnières DIN	Bisagras DIN	10, 12, 15
Charnières DIN pour l'industrie	Bisagras DIN para la industria	11
Charnières en acier inoxydable	Bisagras de acero inoxidable	13, 18-21
Pentures de coffres françaises	Bisagras francesas para cajas	20
Pentures de coffres	Bisagras para cajas	20
Charnières en laiton	Bisagras de latón	14
Bandes à charnière	Bisagras	16, 17
Charnières de serrurier	Bisagras de cerrajero	17
Charnières fortes	Bisagras fuertes	18-19
Pentures anglaise	Bisagras de ramal en T	20
Charnières de table	Bisagras alargadas	16-17



DIN-Scharniere

DIN hinges
Charnières DIN
Bisagras DIN

Gerollte schmale Scharniere DIN 7954 A mit vernietetem Messingstift

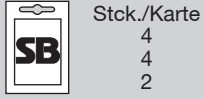

Stck./Karte
4
4
2

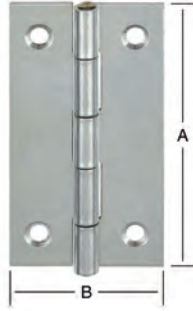

Artikel-Nr.	GTIN 4003984	Ausführung	Abmessungen mm			ca. kg je VE	Schrauben		verp. zu... Stck.
			A	B	Stärke		Stck.	Ø mm	
000501025Z	010603		25	20	0,8	0,27	4	2,0	50
000501030Z	010627		30	22	0,9	0,37	4	2,5	50
000501040Z	010641		40	26	0,9	0,59	4	2,5	50
000501050Z	010665		50	31	1,2	0,39	6	3,0	20
000501060Z	010689		60	34	1,4	0,63	6	3,0	20
000501070Z	010696		70	38	1,4	0,87	6	3,0	20
000501080Z	010719		80	41	1,5	1,15	6	3,5	20
000501090Z	010726		90	46	1,5	1,43	8	3,5	20
000501100Z	010733		100	52	1,6	1,94	8	4,0	20
090850000	410014	Z	25	20	0,8	0,21	4	2,0	5
090851000	410021	Z	40	26	0,9	0,30	4	2,5	5
090852000	410038	Z	50	31	1,2	0,31	6	3,0	5

Gerollte halbbreite Scharniere DIN 7954 B mit vernietetem Messingstift

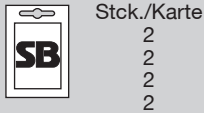

Stck./Karte
2
2
2
2

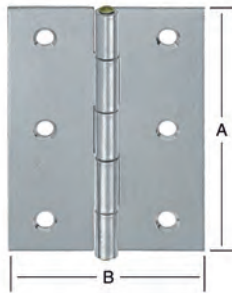

000502025Z	010757		25	22	0,8	0,27	4	2,0	50
000502030Z	010771		30	26	0,9	0,42	4	2,5	50
000502040Z	010801		40	32	0,9	0,66	4	2,5	50
000502050Z	010832		50	39	1,2	0,50	6	3,0	20
000502060Z	010863		60	46	1,4	0,81	6	3,0	20
000502070Z	010887		70	51	1,4	1,05	6	3,5	20
000502080Z	010894		80	58	1,5	1,42	6	3,5	20
000502090Z	010900		90	63	1,5	1,92	6	3,5	20
000502100Z	010917		100	72	1,6	2,39	8	4,0	20
000503025Z	010924		25	25	0,8	0,27	4	2,0	50
000503030Z	010931		30	30	0,9	0,46	4	2,5	50
000503040Z	010955		40	40	0,9	0,77	4	2,5	50
000503050Z	010979		50	50	1,2	0,59	6	3,0	20
000503060Z	010993		60	60	1,4	0,96	6	3,0	20
000503070Z	011006		70	70	1,4	1,35	6	3,5	20
000503080Z	011013		80	80	1,5	1,85	6	3,5	20
000503090Z	011020		90	90	1,5	2,50	8	4,0	20
000503100Z	011037		100	100	1,6	2,97	8	4,0	20
092055000	410304	Z	25	25	0,8	0,17	4	2,0	5
092056000	410311	Z	30	30	0,9	0,20	4	2,5	5
092057000	410328	Z	40	40	0,9	0,26	4	2,5	5
092058000	410335	Z	50	50	1,2	0,40	6	3,0	5

Gerollte breite Scharniere DIN 7954 D mit vernietetem Messingstift



Stck./Karte
2
2

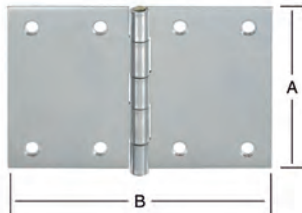

000504025Z	011044		25	38	0,8	0,40	6	2,5	50
000504030Z	011051		30	45	0,9	0,65	6	3,0	50
000504040Z	011068		40	60	1,2	0,61	6	3,0	20
000504050Z	011075		50	75	1,2	0,87	8	3,5	20
000504060Z	011082		60	90	1,4	1,43	8	3,5	20
000504070Z	011099		70	105	1,5	2,15	8	4,0	20
000504080Z	011105		80	120	1,8	3,13	8	4,0	20
000504090Z	011112		90	133	1,8	2,21	8	4,5	10
000504100Z	011129		100	145	2,0	2,64	8	4,5	10
092050000	410267	Z	30	45	0,9	0,24	6	2,5	5
092051000	410274	Z	40	60	1,2	0,40	6	3,0	5

Gerollte breite Tischbänder DIN 7957 mit vernietetem Messingstift

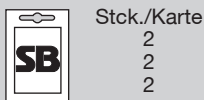

Stck./Karte
2
2
2

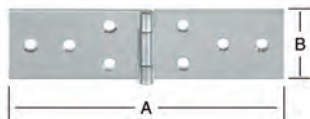

000505050Z	011136		50	23	0,9	0,23	6	2,5	20
000505060Z	011143		60	25	0,9	0,30	6	2,5	20
000505080Z	011150		80	28	1,2	0,53	6	3,0	20
000505100Z	011167		100	32	1,3	0,82	6	3,0	20
000505120Z	011174		120	33	1,4	1,02	8	3,5	20
000505140Z	011181		140	34	1,6	1,36	8	3,5	20
000505160Z	011198		160	37	1,7	1,85	8	3,5	20
000505180Z	011204		180	40	1,7	1,10	8	4,0	10
000505200Z	011211		200	44	2,0	3,03	8	4,0	20
000505250Z	011228		250	44	2,0	3,64	10	4,5	20
092078000	410397	Z	50	23	0,9	0,22	6	2,5	5
092079000	410403	Z	60	25	0,9	0,25	6	2,5	5
092080000	410410	Z	80	28	1,2	0,37	6	3,0	5

Artikel-Nr.	GTIN 4003984	Abmessungen mm			ca. kg je VE	Schrauben		verp. zu... Stck.
		A	B	Stärke		Stck.	Ø mm	
000401025ZL	010016	25	20	0,8	4,75	4	2,0	1000
000401030ZL	010030	30	22	0,9	6,80	4	2,5	1000
000401040ZL	010054	40	26	0,9	9,09	4	2,5	1000
000401050ZL	010078	50	31	1,2	9,56	6	3,0	500
000401060ZL	010092	60	34	1,4	15,16	6	3,0	500
000401080ZL	010115	80	41	1,5	10,98	6	3,5	200

DIN-Scharniere für die Industrie

DIN hinges for industry
Charnières DIN pour l'industrie
Bisagras DIN para la industria



**Gerollte
schmale
Scharniere
DIN 7954 A**
mit vernietetem
Eisenstift



000402040ZL	010153	40	32	0,9	12,66	4	2,5	1000
000402050ZL	010177	50	39	1,2	11,73	6	3,0	500
000402060ZL	010191	60	46	1,4	9,38	6	3,0	250

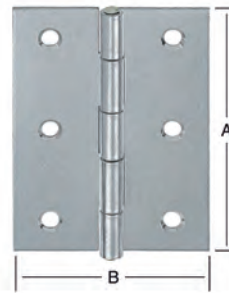

**Gerollte
halbbreite
Scharniere
DIN 7954 B**
mit vernietetem
Eisenstift



000403025ZL	010221	25	25	0,8	5,36	4	2,0	1000
000403030ZL	010245	30	30	0,9	8,45	4	2,5	1000
000403040ZL	010269	40	40	0,9	14,67	4	2,5	1000
000403050ZL	010283	50	50	1,2	14,23	6	3,0	500
000403060ZL	010306	60	60	1,4	9,32	6	3,0	200
000403070ZL	010320	70	70	1,4	6,72	6	3,5	100
000403080ZL	010344	80	80	1,5	8,96	6	3,5	100
000403100ZL	010368	100	100	1,6	15,21	8	4,0	100

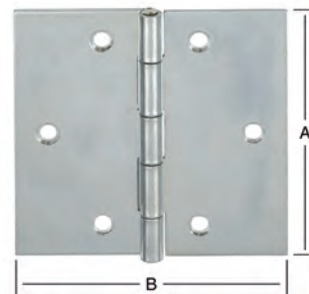

**Gerollte
kältige
Scharniere
DIN 7954 C**
mit vernietetem
Eisenstift



000404040ZL	010405	40	60	1,2	14,43	6	3,0	500
000404050ZL	010429	50	75	1,2	8,37	8	3,5	200
000404060ZL	010443	60	90	1,4	7,01	8	3,5	100

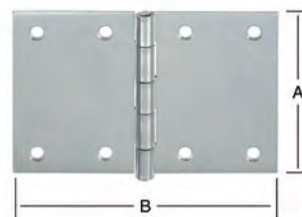

**Gerollte
breite
Scharniere
DIN 7954 D**
mit vernietetem
Eisenstift



000405050ZL	010474	50	23	0,9	10,21	6	2,5	1000
000405060ZL	010498	60	25	0,9	13,33	6	2,5	1000
000405080ZL	010511	80	28	1,2	13,13	6	3,0	500
000405100ZL	010535	100	32	1,3	9,63	6	3,0	250
000405120ZL	010542	120	33	1,4	4,95	8	3,5	100
000405140ZL	010566	140	34	1,6	6,65	8	3,5	100
000405160ZL	010580	160	37	1,7	8,80	8	3,5	100

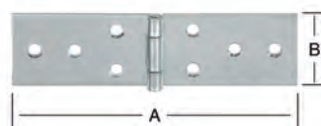

**Gerollte
breite
Tischbänder
DIN 7957**
mit vernietetem
Eisenstift





DIN-Scharniere

DIN hinges
Charnières DIN
Bisagras DIN

Gerollte schmale Scharniere DIN 7954 A mit vernietetem Messingstift

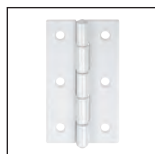
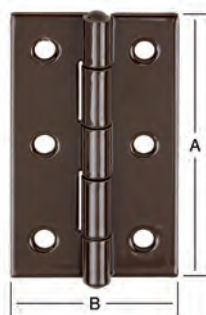

Artikel-Nr.	GTIN 4003984	Ausführung	Abmessungen mm			ca. kg je VE	Schrauben		verp. zu... Stck.
			A	B	Stärke		Stck.	Ø mm	
000501060B	040044		60	34	1,4	0,33	6	3,0	10
000501080W	040211		80	41	1,5	0,59	6	3,5	10
000501060S	192002		60	34	1,4	0,63	6	3,0	20
000501080S	192019		80	41	1,5	0,59	6	3,5	10

Gerollte kántige Scharniere DIN 7954 C mit vernietetem Messingstift

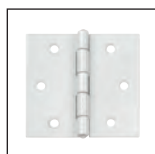
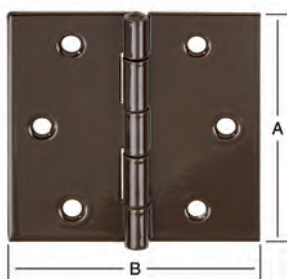

000503060B	040105		60	60	1,4	0,99	6	3,0	20
000503060W	040228		60	60	1,4	0,49	6	3,0	10
000503070W	040235		70	70	1,4	0,69	6	3,5	10

Gerollte breite Scharniere DIN 7954 D mit vernietetem Messingstift

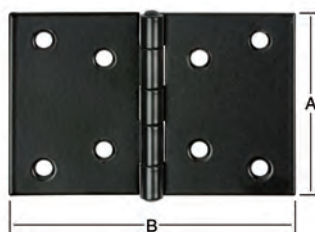

000504060S	192026		60	90	1,4	1,43	8	3,5	20
000504080S	192033		80	120	1,8	3,13	8	4,0	20



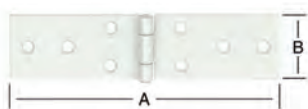

Gerollte breite Tischbänder DIN 7957 mit vernietetem Messingstift



000505140W	040259		140	34	1,5	1,37	8	3,5	20
------------	--------	--	-----	----	-----	------	---	-----	----

Edelstahl-Scharniere

Stainless steel hinges
Charnières en acier inoxydable
Bisagras de acero inoxidable

Artikel-Nr.	GTIN 4003984	Ausführung	Abmessungen mm			ca. kg je VE	Schrauben		verp. zu... Stck.
			A	B	Stärke		Stck.	Ø mm	
010501030	020107		30	22	0,8	0,32	4	2,5	50
010501040	020114		40	26	0,9	0,56	4	2,5	50
010501050	020121		50	31	1,0	0,37	6	3,0	20
010501060	020145		60	34	1,2	0,28	6	3,0	10
010501080	020152		80	41	1,5	0,58	6	3,5	10
010501100	020169		100	52	1,5	0,92	8	4,0	10
									
092028000	510332		40	26	0,9	0,22	4	2,5	5
092029000	510349		50	31	1,0	0,33	6	3,0	5
092030000	510356		60	34	1,2	0,38	6	3,0	5

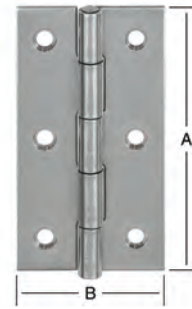

**Gerollte
schmale
Edelstahl-
Scharniere**
mit vernietetem
Edelstahlstift



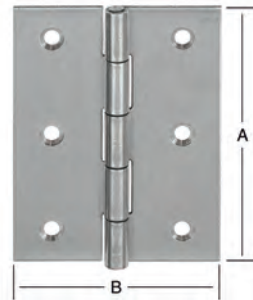

	Stck./Karte
	2
	2
	2

010502040	020176		40	32	0,9	0,61	4	2,5	50
010502050	020183		50	39	1,0	0,44	6	3,0	20
010502060	020190		60	46	1,2	0,69	6	3,0	20
010502080	020213		80	58	1,5	1,43	6	3,5	20
010502100	020220		100	72	1,5	2,24	8	4,0	20
									



**Gerollte
halbbreite
Edelstahl-
Scharniere**
mit vernietetem
Edelstahlstift



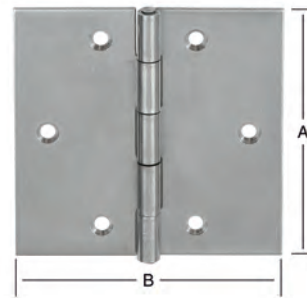

010503030	020237		30	30	0,8	0,39	4	2,5	50
010503040	020244		40	40	0,9	0,76	4	2,5	50
010503050	020268		50	50	1,0	0,52	6	3,0	20
010503060	020275		60	60	1,2	0,44	6	3,0	10
010503070	020282		70	70	1,2	0,62	6	3,5	10
010503080	020299		80	80	1,5	0,95	6	3,5	10
010503100	020305		100	100	1,5	1,46	8	4,0	10
									
092033000	510387		40	40	0,9	0,25	4	2,5	5



**Gerollte
kántige
Edelstahl-
Scharniere**
mit vernietetem
Edelstahlstift



	Stck./Karte
	2

010504030	020312		30	45	1,0	0,72	6	3,0	50
010504040	020329		40	60	0,9	0,46	6	3,0	20
010504050	020336		50	75	1,2	0,41	8	3,5	10
010504060	020343		60	90	1,2	0,65	8	3,5	10
010504080	020367		80	120	1,5	1,43	8	4,0	10
									

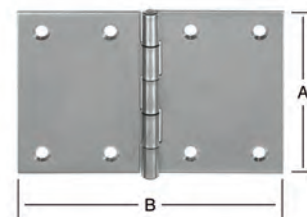

**Gerollte
breite
Edelstahl-
Scharniere**
mit vernietetem
Edelstahlstift



010505080	020374		80	28	1,0	0,24	6	3,0	10
010505100	020381		100	32	1,2	0,40	6	3,0	10
010505120	020404		120	33	1,2	0,41	8	3,5	10
010505140	020411		140	34	1,5	0,64	8	3,5	10
010505160	020428		160	37	1,5	0,83	8	3,5	10
									

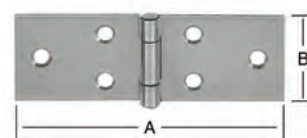

**Gerollte
breite
Edelstahl-
Tischbänder**
mit vernietetem
Edelstahlstift





Messing-Scharniere

Brass hinges
Charnières en laiton
Bisagras de latón

Gerollte schmale Messing- Scharniere mit vernietetem Messingstift



Stck./Karte
4
2

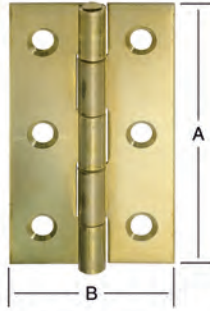

Artikel-Nr.	GTIN 4003984	Ausführung	Abmessungen mm			ca. kg je VE	Schrauben		verp. zu... Stck.
			A	B	Stärke		Stck.	Ø mm	
020501025	030014		25	20	0,8	0,26	4	2,0	50
020501030	030038		30	22	0,8	0,34	4	2,5	50
020501040	030052		40	26	0,9	0,62	4	2,5	50
020501050	030076		50	31	1,1	0,41	6	3,0	20
020501060	030090		60	34	1,3	0,64	6	3,0	20
090870000	410076		25	20	0,8	0,22	4	2,0	5
090871000	410083		40	26	0,9	0,23	4	2,5	5

MESSING

Gerollte halbbreite Messing- Scharniere mit vernietetem Messingstift

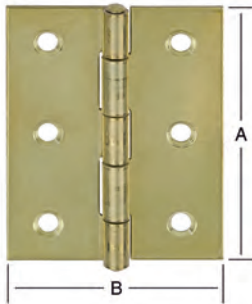

020502040	030120		40	32	0,9	0,69	4	2,5	50
020502050	030137		50	39	1,1	0,50	6	3,0	20
020502060	030144		60	46	1,3	0,82	6	3,0	20

MESSING

Gerollte kältige Messing- Scharniere mit vernietetem Messingstift



Stck./Karte
2

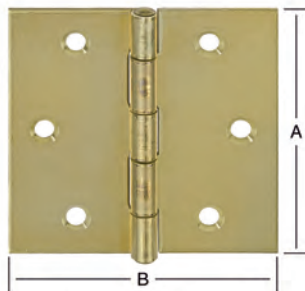

020503040	030205		40	40	0,9	0,82	4	2,5	50
020503050	030229		50	50	1,1	0,60	6	3,0	20
020503060	030243		60	60	1,3	1,00	6	3,0	20
092061000	410366		40	40	0,9	0,50	4	2,5	10

MESSING

Artikel-Nr.	GTIN 4003984	Abmessungen mm			ca. kg je VE	Schrauben		verp. zu... Stck.
		A	B	Stärke		Stck.	Ø mm	
000701080Z	060073	80	41	1,8	1,17	6	3,5	20

**Geschlagene
schmale
Scharniere
DIN 7955 A**
mit vernietetem
Eisenstift

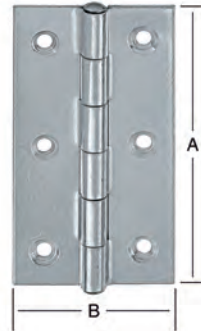

000703060Z	060264	60	60	1,8	1,18	6	3,5	20
000703080Z	060295	80	80	2,0	2,27	6	3,5	20
000703100Z	060325	100	100	2,3	4,38	8	4,0	20

**Geschlagene
kántige
Scharniere
DIN 7955 C**
mit vernietetem
Messingstift

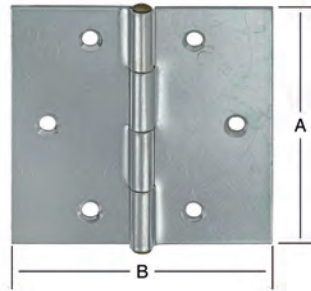

000704050Z	060363	50	75	2,0	3,07	8	3,5	50
000704060Z	060387	60	90	2,0	1,91	8	4,0	20
000704080Z	060417	80	120	2,4	4,10	8	4,0	20
000704100Z	060424	100	150	3,0	7,66	8	5,0	20

**Geschlagene
breite
Scharniere
DIN 7955 D**
mit vernietetem
Messingstift

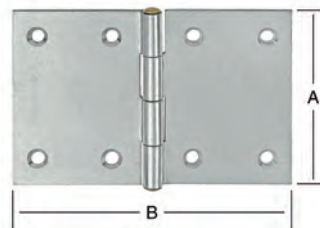

mit vernietetem
Eisenstift



000705180Z	060509	180	40	2,4	3,62	8	4,0	20
------------	--------	-----	----	-----	------	---	-----	----

**Geschlagene
breite
Tischbänder
DIN 7958**
mit vernietetem
Eisenstift

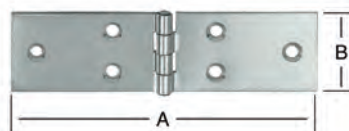



Tischbänder

Flap hinges
Charnières de table
Bisagras alargadas

Gerollte schmale Tischbänder mit vernietetem Eisenstift



verzinkt



Stck./Karte
2

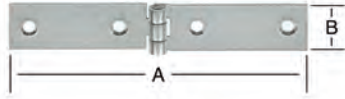

Artikel-Nr.	GTIN 4003984	Abmessungen mm			ca. kg je VE	Schrauben		verp. zu... Stck.
		A	B	Stärke		Stck.	Ø mm	
000506100Z	011242	100	20	1,5	1,43	4	3,5	50
000506120Z	011266	120	20	1,5	1,72	4	3,5	50
000506815Z	011280	80	15	1,5	0,88	4	3,0	50
000506820Z	011303	80	20	1,5	1,20	4	3,5	50
092087000	410489	100	20	1,5	0,39	4	3,5	5

Geschlagene schmale Tischbänder mit vernietetem Eisenstift

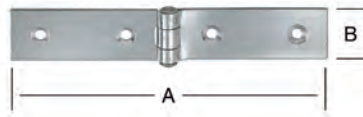

000706120Z	060547	120	20	2,4	2,48	4	3,5	50
------------	--------	-----	----	-----	------	---	-----	----

Geschlagene starke schmale Tischbänder mit vernietetem Messingstift

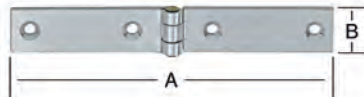

000047000Z	070508	140	20	3,4	0,78	4	4,0	10
------------	--------	-----	----	-----	------	---	-----	----

Geschlagene extra starke schmale Scharnier- bänder mit vernietetem Eisenstift

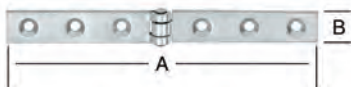

000007200Z	070225	200	20	5,0	3,02	6	6,0	20
------------	--------	-----	----	-----	------	---	-----	----

Scharnierbänder



Strap hinges
Bandes à charnière
Bisagras

Artikel-Nr.	GTIN 4003984	Abmessungen mm			ca. kg je VE	Schrauben		verp. zu... Stck.
		A	B	Stärke		Stck.	Ø mm	
000003040Z	070034	40	40	2,4	0,73	4	3,5	20
000003050Z	070041	50	50	2,4	1,05	6	4,0	20
000003060Z	070065	60	60	2,8	1,70	6	4,5	20
000003080Z	070096	80	80	3,0	3,37	6	5,0	20
000003100Z	070102	100	100	3,2	2,78	6	6,0	10

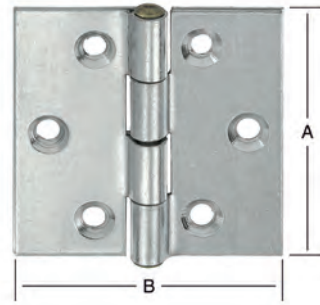

**Geschlagene
starke
Schlosser-
scharniere**
mit vernietetem
Messingstift



000004060Z	070140	60	90	2,8	2,51	8	4,5	20
000004080Z	070164	80	120	3,4	5,29	8	5,0	20

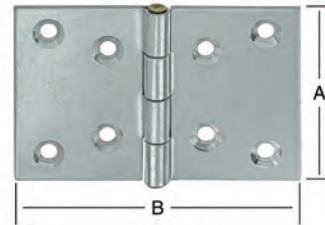

**Geschlagene
starke breite
Schlosser-
scharniere**
mit vernietetem
Messingstift



000005140Z	070195	140	32	3,0	2,16	8	4,5	20
------------	--------	-----	----	-----	------	---	-----	----

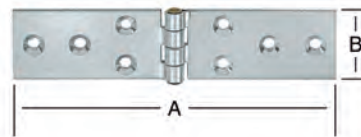

**Geschlagene
starke
Schlosser-
Tischbänder**
mit vernietetem
Messingstift



000010408Z	070249	40	80	2,4	1,28	6	4,5	20
000010510Z	070270	50	100	3,0	2,41	6	5,0	20
000010512Z	070287	50	120	3,0	2,91	6	5,0	20
000010514Z	070294	50	140	3,4	1,92	8	5,0	10
000010620Z	070355	60	200	4,0	3,96	8	5,0	10

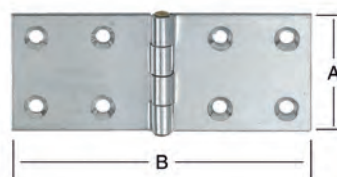

**Geschlagene
extra starke
breite
Scharnier-
bänder**
mit vernietetem
Messingstift





Starke Scharniere

Strong hinges
Charnières fortes
Bisagras fuertes

Gerollte starke schmale Scharniere
mit durchgedrücktem Gewerbe
mit vernietetem Eisenstift

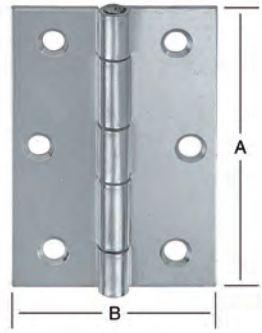

Artikel-Nr.	GTIN 4003984	Abmessungen mm			ca. kg je VE	Schrauben		verp. zu... Stck.
		A	B	Stärke		Stck.	Ø mm	
000611050Z	050197	50	38	1,5	0,79	4	3,5	24
000611060Z	050203	63	42	1,5	1,07	6	3,5	24
000611075Z	050210	75	50	1,6	1,29	6	3,5	24
000611100Z	050227	100	73	1,9	1,86	8	4,5	12

Gerollte starke kältige Scharniere
mit durchgedrücktem Gewerbe
mit vernietetem Eisenstift

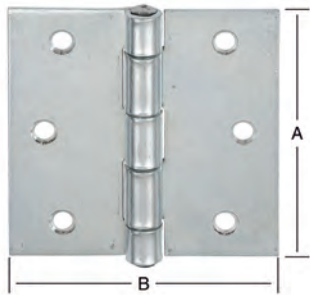

mit vernietetem
Messingstift

mit vernietetem
Edelstahlstift

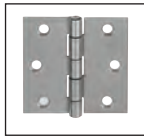

000613050Z	050289	50	50	1,5	1,10	4	4,0	24
000613060Z	050296	63	63	1,8	0,95	6	4,0	12
000613075Z	050302	75	75	2,0	1,52	6	4,0	12
000613100Z	050319	100	100	2,2	2,81	8	5,0	12
010613060	020602	63	63	1,5	1,54	6	4,0	24



V2A

Gerollte starke breite Scharniere
mit durchgedrücktem Gewerbe
mit vernietetem Messingstift

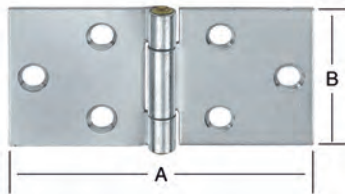

000030080Z	050111	80	40	1,5	0,98	6	4,0	20
000030100Z	050135	100	44	2,0	1,52	6	4,5	20

Gerollte extra starke breite Scharniere
mit vernietetem Messingstift

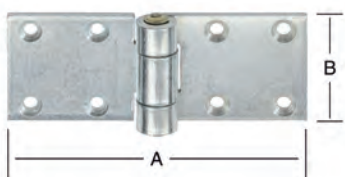

000048130Z	050180	130	50	4,0	2,76	8	5,0	10
000048180Z	050555	180	50	4,0	1,77	10	5,0	5

Starke Scharniere

Strong hinges
Charnières fortes
Bisagras fuertes

Artikel-Nr.	GTIN 4003984	Abmessungen mm			ca. kg je VE	Schrauben		verp. zu... Stck.
		A	B	Stärke		Stck.	Ø mm	
000612040Z	050234	38	37	1,4	0,50	4	3,0	24
000612050Z	050241	50	38	1,5	0,80	4	3,5	24
000612060Z	050258	63	42	1,5	1,07	6	3,5	24
000612075Z	050265	75	50	1,6	1,48	6	3,5	24
000612100Z	050272	100	73	1,9	1,89	8	4,5	12

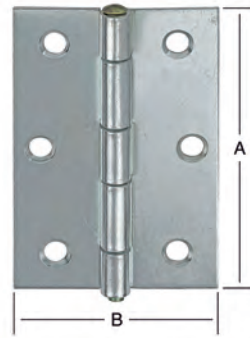

Gerollte starke halbbreite Scharniere
mit durchgedrücktem Gewerbe, mit losem **Messing-Knopfstift**



000614050Z	050326	50	50	1,5	1,05	4	4,0	24
000614060Z	050340	63	63	1,8	0,95	6	4,0	12
000614075Z	050371	75	75	2,0	1,51	6	4,0	12
000614090Z	050401	89	89	2,1	2,27	6	4,5	12
000614100Z	050425	100	100	2,2	2,81	8	5,0	12
000614756Z	050432	75	60	1,9	2,52	6	4,0	24

010614060	020435	63	63	1,5	1,54	6	4,0	24
010614075	020442	75	75	1,75	1,38	6	4,0	12
010614090	020459	90	90	1,75	1,97	6	4,5	12

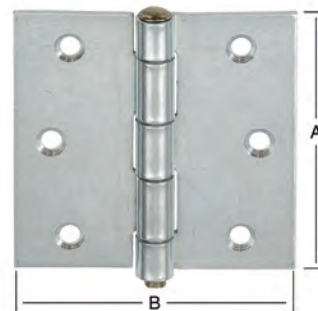

Gerollte starke kältige Scharniere
mit durchgedrücktem Gewerbe, mit losem **Messing-Knopfstift**

mit losem **Edelstahl-Knopfstift**



000614060ZR	050548	63	63	1,8	1,99	6	4,0	24
000614075ZR	050531	75	75	2,0	1,62	6	4,0	12
000614090ZR	050524	90	89	2,1	2,43	6	4,5	12



Gerollte kältige Scharniere
mit durchgedrücktem Gewerbe, **ohne Axialspiel**, mit aushebbarem Ringstift

000614060ZR
Stift-Ø = 5 x 80 mm
000614075ZR
Stift-Ø = 6 x 100 mm
000614090ZR
Stift-Ø = 7 x 120 mm



010617075	020572	75	75	1,75	2,73	6	4,0	24
-----------	--------	----	----	------	------	---	-----	----

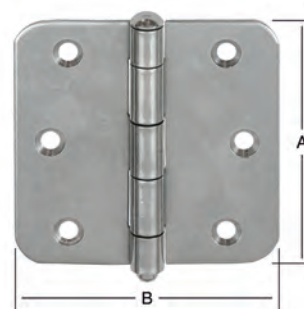

Gerollte starke kältige Edelstahl-Scharniere
mit durchgedrücktem Gewerbe, mit abgerundeten Ecken (Rad. 10 mm) mit losem **Edelstahl-Knopfstift**





Kistenbänder

Case hinges
Pentures de coffres
Bisagras para cajas

Gerollte starke französische Kistenbänder

mit vernietetem Messingstift, mit versenkten Schraublöchern

mit verzinktem Stahlstift

mit Edelstahlstift

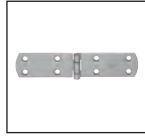

Gerollte starke Kistenbänder

mit vernietetem Eisenstift und versenkten Schraublöchern

Eisen blank ungebohrt

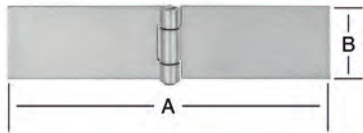
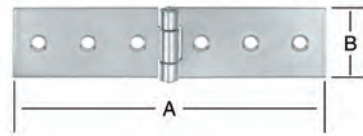
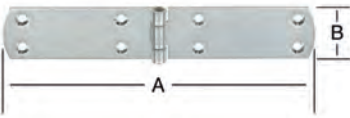

Gerollte starke Kistenbänder

mit Schraublöchern mit vernietetem Edelstahlstift

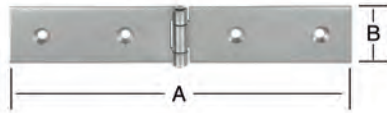

Gerollte Kistenbänder

mit vernietetem Eisenstift und versenkten Schraublöchern

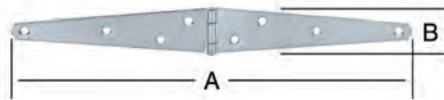

Gerollte T-Bänder

mit vernietetem Eisenstift und versenkten Schraublöchern

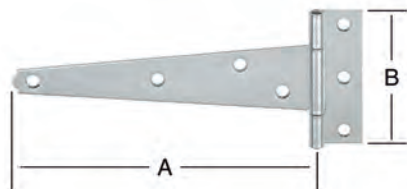

Artikel-Nr.	GTIN 4003984	Abmessungen mm			ca. kg je VE	Schrauben		verp. zu... Stck.
		A	B	Stärke		Stck.	Ø mm	
000028120Z	080125	120	30	2,0	1,28	6	4,0	20
000028140Z	080132	140	35	2,0	1,79	8	4,0	20
000028160Z	080156	160	35	2,0	1,97	8	4,0	20
000028180Z	080163	180	35	2,0	2,24	8	4,0	20
000028200Z	080187	200	35	2,0	1,18	8	4,0	10
000028250Z	080194	250	38	2,5	1,99	10	5,0	10
000028300Z	080217	300	38	2,5	2,42	10	5,0	10
000028400Z	080231	400	40	3,0	4,00	10	5,0	10
000028500Z	080248	500	40	3,0	4,46	10	5,0	10
010028160	020619	160	35	2,0	0,99	8	4,0	10
010028200	020626	200	35	2,0	1,21	8	4,0	10
V2A								

000217170Z	080583	170	40	2,5	3,04	6	4,5	20
000217200Z	080699	200	40	3,0	4,23	6	5,0	20
000217170U	080576	170	40	2,5	0,15	-	-	1
000217200U	080606	200	40	3,0	0,21	-	-	1

010096200	180092	200	35	2,0	0,64	4	5,0	5
V2A								

000044100Z	080316	193	29	1,5	1,11	6	3,0	20
000044125Z	080798	242	33	1,5	1,47	6	3,5	20
000044150Z	080323	292	33	1,5	1,80	8	3,5	20
000044200Z	080781	390	44	2,0	2,06	8	4,0	10

000042100Z	080262	97	60	1,5	0,54	6	3,0	10
000042125Z	080279	121	68	1,5	0,71	6	3,5	10
000042150Z	080286	146	68	1,5	0,80	7	3,5	10
000042200Z	080293	195	88	2,0	1,84	7	4,0	10
000042250Z	080774	245	100	2,0	2,36	8	4,0	10



Artikel-Nr.	GTIN 4003984	Abmessungen mm			ca. kg je VE	Schrauben		verp. zu... Stck.
		A A ₁ A ₂	B	Stärke		Stck.	Ø mm	
010043080	180054	80 28	37	1,5	0,95	6	4,0	20
								

**Gerollte
Edelstahl-
bänder**
 mit vernietetem
Edelstahlstift und
 versenkten
 Schraublöchern

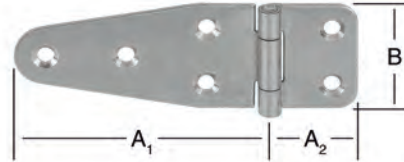

010046070	180542	70	40	1,5	0,72	6	3,0	20
								

**Gerollte
Edelstahl-
bänder**
 mit vernietetem
Edelstahlstift und
 versenkten
 Schraublöchern

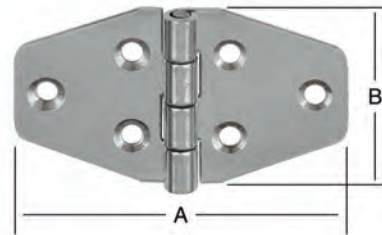

010046160	180061	160	37	1,5	1,24	8	4,0	20
								

**Gerollte
Edelstahl-
bänder**
 mit vernietetem
Edelstahlstift und
 versenkten
 Schraublöchern

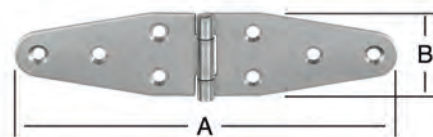



Spezialscharniere

Special hinges
Charnières spéciales
Bisagras especiales

Seite

page

page

página



27	Aufschraubbänder	Screw-on hinges
28, 29	Aushebescharniere	Lift-off hinges
25, 27-28	Edelstahl-Scharniere	Stainless steel hinges
29	Fensterscharniere	Window hinges
29	Klappenscharniere	Flap hinges
24	Kulissenscharniere	Scenery hinges
29	Kunststoffscharniere	Plastic hinges
26	Lamellentürscharniere	Lamella-door hinges
30	Leiterbänder	Ladder hinges
26	Messingscharniere	Brass hinges
26, 27	Möbelscharniere	Furniture hinges
27	Normenscharniere	Standard hinges
26	Paraventscharniere	Screen hinges
29	Pendeltürbänder	Swing door hinges
27	Reparaturbänder	Repair strips
26	Schatullenscharniere	Casket hinges
30	Schulwandtafelscharniere	Blackboard hinges
24-30	Spezialscharniere	Special hinges
25	Stangenscharniere	Piano hinges
27, 28	Türscharniere	Door hinges
29	Verbundfensterscharniere	Composite window hinges

**F****E**Seite
page
page
página

Paumelles à visser	Bisagras para atornillar	27
Charnières dégonflables	Bisagras extraíbles	28, 29
Charnières en acier inoxydable	Bisagras de acero inoxidable	25, 27-28
Charnières de fenêtre	Bisagras para ventanas	29
Charnières d'abattant	Bisagras para fijación de puertas abatibles	29
Charnières à broche amovible	Bisagras de corredera	24
Charnières en plastique	Bisagras de plástico	29
Charnières de portes à lamelle	Bisagras de puerta Louvre	26
Charnières d'échelle	Bisagras para escaleras curvadas	30
Charnières en laiton	Bisagras de latón	26
Charnières de meubles	Bisagras para muebles	26, 27
Charnières standard	Bisagras estándar	27
Charnières de paravents	Bisagras para biombos	26
Paumelles de portes va-et-vient	Pernios para puertas de vaivén	29
Paumelles de secours	Pernios de reparación	27
Charnières coffret	Bisagras para cofres	26
Charnières de tableau noir	Bisagras para pizarras	30
Charnières spéciales	Bisagras especiales	24-30
Charnières à piano	Bisagras corridas tipo piano	25
Charnières de porte	Bisagras de puerta	27, 28
Charnières de fenêtres à survitrages	Bisagras ventanas de contravidriera	29



Kulissenscharniere

Scenery hinges
Charnières à broche amovible
Bisagras de corredera

Geschlagene Kulissenscharniere

DIN 56923
mit 2 mm Axialspiel,
verzinkt, mit ausheb-
barem Ringstift verzinkt
Stift-Ø = 6 x 100 mm

eisenblank,
Ringstift eisenblank

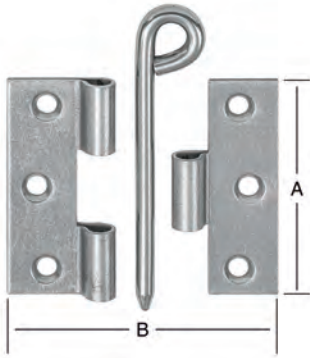

Artikel-Nr.	GTIN 4003984	Abmessungen mm			ca. kg je VE	Schrauben		verp. zu... Stck.
		A	B	Stärke		Stck.	Ø mm	
000056070ZR	130158	70	55	3,0	2,30	6	4,5	20
000056070RI	130035	70	55	3,0	5,72	6	4,5	50
000057050RI	130059	50	50	2,5	3,70	6	4,5	50
000057060RI	130066	60	60	3,0	5,71	6	4,5	50
000058457RI	130073	45	70	3,0	4,86	8	4,5	50
000058510RI	130080	50	100	3,0	7,36	6	4,5	50
000058609RI	130097	60	90	3,0	7,67	8	4,5	50
000058612RI	130103	60	120	3,0	9,59	8	4,5	50
000058812RI	130127	80	120	3,0	4,93	10	4,5	20

Geschlagene Kulissenscharniere

DIN 56923
mit 10 mm Axialspiel,
eisenblank,
mit ausheb-
barem Ringstift eisenblank
Stift-Ø = 6 x 100 mm

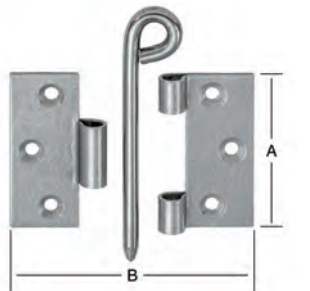

000058619RI

000056170RI	130042	70	55	3,0	5,68	6	4,5	50
000057160RI	102490	60	60	3,0	5,40	6	4,5	50
000058619RI	130110	60	90	3,0	7,62	8	4,5	50

Gerollte Kulissenscharniere

mit 2 mm Axialspiel,
eisenblank,
mit ausheb-
barem Ringstift eisenblank
Stift-Ø = 6 x 100 mm

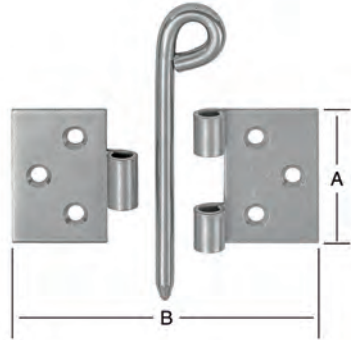

000059045RI	130134	45	70	1,75	3,97	6	4,0	50
000059060RI	130141	60	95	2,0	6,51	8	4,5	50

Gerollte kältige Scharniere

mit durchgedrücktem
Gewerbe, verzinkt
ohne Axialspiel,
mit ausheb-
barem Ringstift verzinkt

000614060ZR
Stift-Ø = 5 x 80 mm
000614075ZR
Stift-Ø = 6 x 100 mm
000614090ZR
Stift-Ø = 7 x 120 mm

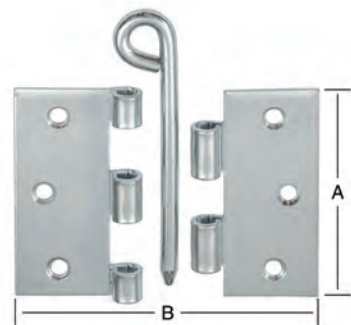

000614060ZR	050548	63	63	1,8	1,99	6	4,0	24
000614075ZR	050531	75	75	2,0	1,52	6	4,0	12
000614090ZR	050524	90	89	2,1	2,43	6	4,5	12

Stangenscharniere

Piano hinges
Charnières à piano
Bisagras corridas tipo piano



Artikel-Nr.	GTIN 4003984	Ausführung	Abmessungen mm			Ø Stift	ca. kg je VE	Schrauben		verp. zu... Stck.
			A	B	Stärke			Stck.	Ø mm	
000450032N	110044	N	2040	32	0,7	1,7	5,58	68	2,5	10
010450032 010450040 	020015		2040	32	0,7	1,7	5,62	68	2,5	10
	020039		2040	40	0,7	1,7	6,33	68	2,5	10

Gerollte Stangen scharniere

ähnlich DIN 7956

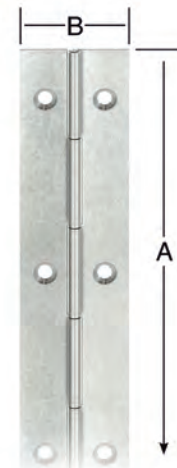
Teilung:
15 mm



010450032U 	020022		2040	32	0,7	1,7	5,65	–	–	10
000460004 000460040 000460050 000460060	110112		2040	40	1,5	3,0	7,54	–	–	5
	110136		2040	40	2,0	6,0	25,13	–	–	10
	110150		2040	50	2,0	6,0	14,15	–	–	5
	110167		2040	60	2,0	6,0	15,66	–	–	5
010460003 010460004 010460005 010460050 010460060 	020053		2040	32	1,5	3,0	6,86	–	–	5
	020060		2040	40	1,5	3,0	7,75	–	–	5
	020077		2040	50	1,5	3,0	8,79	–	–	5
	020084		2040	50	2,0	6,0	14,09	–	–	5
	020091		2040	60	2,0	6,0	15,38	–	–	5

Gerollte ungebohrte Stangen- scharniere

(Haubenscharniere)
eisenblank

Teilung:
15 mm

Teilung:
30 mm

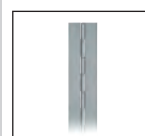
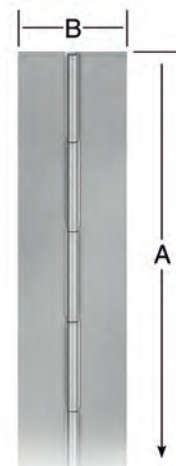

Schatullen-/Möbelscharniere

Casket hinges / Furniture hinges
 Charnières coffret / Charnières de meubles
 Bisagra para cofres / Bisagras para muebles

Gerollte Schatullen-Scharniere

vermessingt
 mit Nagellöchern



Stck./Karte
 6

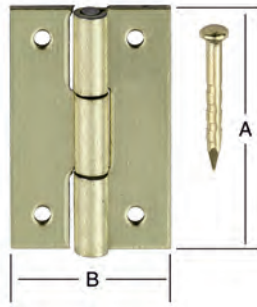

Artikel-Nr.	GTIN 4003984	Ausführung	Abmessungen mm			ca. kg je VE	Schrauben		verp. zu... Stck.
			A A ₁ A ₂	B B ₁ B ₂	Stärke		Stck.	Ø mm	
090859000	550055	V	15	10	0,5	0,15	Nägel 24	0,9	5

Gerollte Schatullen-Scharniere

vermessingt
 mit Schraublöchern



Stck./Karte
 4
 4
 4

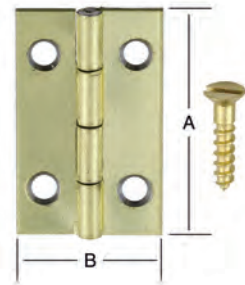

090858000	550253	V	20	12	0,5	0,16	16	2,0	5
090861000	550079	V	30	16	0,7	0,22	16	2,0	5
090862000	550260	V	40	25	0,7	0,29	16	2,5	5

Gerollte Lamellentür-Scharniere

mit durchgedrücktem
 Gewerbe, mit Kunst-
 stoff- Zwischenringen

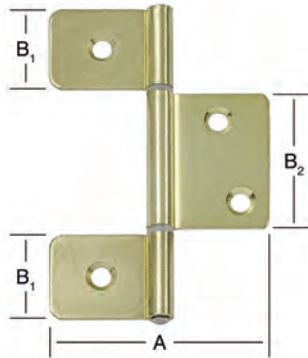

000623000V	120234	V	58	23 38	1,4	1,00	4	3,5	20
------------	--------	---	----	----------	-----	------	---	-----	----

Messing-Paravent-Scharniere

3-teilig

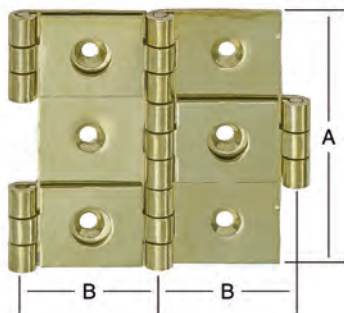

020694525P	120364		50	25	1,25	0,98	6	3,5	20
020694630P	120371		60	30	1,25	1,59	6	3,5	20

MESSING

Möbel-/Türscharniere

Furniture hinges / Door hinges
Charnières de meubles / Charnières de porte
Bisagras para muebles / Bisagras de puerta

Artikel-Nr.	GTIN 4003984	Ausführung	Abmessungen mm			ca. kg je VE	Schrauben		verp. zu... Stck.
			A	B	Stärke		Stck.	Ø mm	
000620050N 000620051N	120173 120197		50 50	40 40	1,5 1,5	0,83 0,83	6 6	3,0 3,0	20 20
000620050NL 000620051NL	120180 120203		50 50	40 40	1,5 1,5	9,65 9,65	6 6	3,0 3,0	250 250
000620050V 000620051V	120395 120401		50 50	40 40	1,5 1,5	0,80 0,80	6 6	3,0 3,0	20 20
010620050 010620051	020466 020473		50 50	40 40	1,5 1,5	0,80 0,80	6 6	3,0 3,0	20 20
									
092096000 092097000	550154 550161	N N	50 50	40 40	1,5 1,5	0,50 0,50	6 6	3,0 3,0	5 5

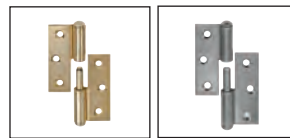

Gerollte Normenscharniere

aushebbar, gerade, mit durchgedrücktem Gewerbe (Abb. ist links)

050 = linke Ausf.
051 = rechte Ausf.



Stck./Karte
2 links
2 rechts

000621050N 000621051N	120210 120227		50 50	35 35	1,5 1,5	0,92 0,92	6 6	3,0 3,0	20 20
000621050V 000621051V	120418 120425		50 50	35 35	1,5 1,5	0,92 0,92	6 6	3,0 3,0	20 20



Gerollte Normenscharniere

aushebbar, gekröpft, Kröpfung D = 7,5 mm (Abb. ist rechts)

050 = linke Ausf.
051 = rechte Ausf.

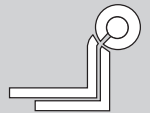

092460000	420280	Z	14	83	2,5	1,12	6	5,0	5
-----------	--------	---	----	----	-----	------	---	-----	---

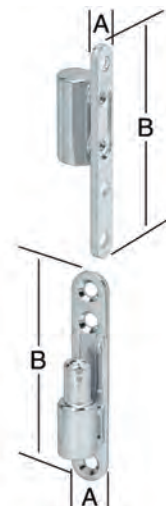

Reparaturband

für Fenster und Türen



Stck./Karte
2





Türscharniere

Door hinges
Charnières de porte
Bisagras de puerta

Gerollte Edelstahl- Türscharniere

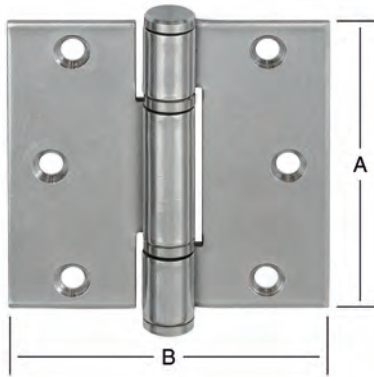
mit durchgedrücktem
Gewerbe,
mit **Edelstahl-
Zylinder-Stift**,
mit Edelstahl-
Zwischenringen
Oberfläche
trowalisiert



Artikel-Nr.	GTIN 4003984	Ausführung	Abmessungen mm			ca. kg je VE	Schrauben		verp. zu... Stck.
			A	B	Stärke		Stck.	Ø mm	
010870075	020497		75	75	2,5	0,36	6	4,0	2
010870090	020503		90	85	2,5	0,46	6	4,5	2
									

Gerollte aushebbare Edelstahl- Türscharniere

mit durchgedrücktem
Gewerbe,
mit **Edelstahl-
Zylinder-Stift**,
und Edelstahl-
Zwischenringen
Oberfläche
trowalisiert
(Abb. ist links)
010871 = links
010872 = rechts

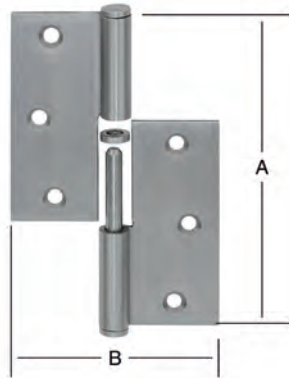

010871090	020527		90	90	2,5	0,44	6	4,0	2
010872090	020541		90	90	2,5	0,44	6	4,0	2
									

Gerollte schwere gerade Kugellager- Türscharniere

Gewerbe durchge-
drückt, aushebbarer
Eisenstift, Flachkopf

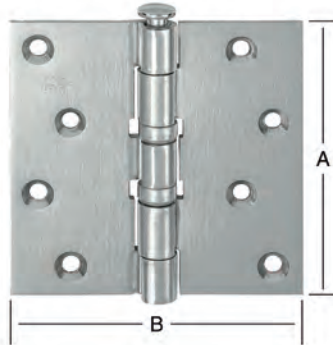

000855006NM	090209		102	76	2,9	0,56	8	5,0	2
000855008NM	090254		102	102	2,9	0,68	8	5,0	2

Tür- Aufschraub- bänder Q1

mit durchgedrücktem
Gewerbe
Q1 mit festem Stift
(Abb. ist rechts)

080 = linke Ausf.
081 = rechte Ausf.

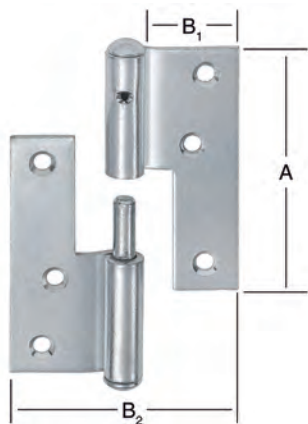

000861080Z	090391		80	B ₁ /B ₂ 30/70	2,5	1,53	6	4,0	10
000861081Z	090407		80	30/70	2,5	1,53	6	4,0	10

Artikel-Nr.	GTIN 4003984	Ausführung	Abmessungen mm			ca. kg je VE	Schrauben		verp. zu... Stck.
			A	B	Stärke		Stck.	Ø mm	

000440060PS	120456		48	58	8,3	0,37	4	5,0	10
000440061PS	120463		48	58	8,3	0,38	4	5,0	10

Kunststoff- / Spezialscharniere

Plastic hinges / Special hinges
Charnières en plastique / Charnières spéciales
Bisagras de plástico / Bisagras especiales



Polyamid-Aushebescharnier
mit Edelstahlstift
(Abb. ist rechts)
060 = links
061 = rechts

000445040PS	120494		30	39	5,0	0,09	4	5,0	10
000445060PS	120500		48	58	8,3	0,40	4	5,0	10
000445100PS	120524		48	96	8,2	0,55	4	5,0	10

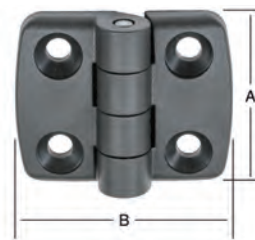

Polyamid-Scharnier
mit Edelstahlstift

000850050Z	090575		50	32	1,7	0,54	6	4,0	2
------------	--------	--	----	----	-----	------	---	-----	---

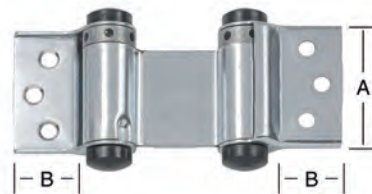

Pendeltürbänder
mit Spiralfeder für
Türen bis 29 mm
Stärke (inkl. Zubehör)

Belastbarkeit
8 kg pro Paar

000632000ZR	050456		75	65	2,5	2,75	6	4,5	20
-------------	--------	--	----	----	-----	------	---	-----	----

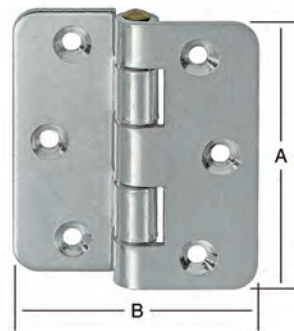

Gerollte Verbundfensterscharniere
mit abgerundeten
Ecken und vernietetem
Messingstift

Kröpfung B

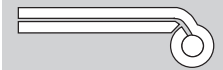

000029608Z	050036		60	80	2	2,00	8	5,0	20
000029609Z	050043		60	80	2	2,00	8	5,0	20
000029710Z	050050		70	100	2	1,48	8	5,0	10
000029711Z	050067		70	100	2	1,48	8	5,0	10
000029812Z	050098		80	120	2	3,86	8	5,0	20
000029813Z	050104		80	120	2	3,86	8	5,0	20

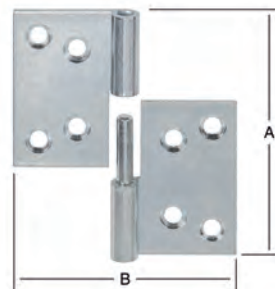

Gerollte Aushebescharniere
(Abb. links)

608, 710, 812
= linke Ausf.
609, 711, 813
= rechte Ausf.



000013000Z	120388		150	45	5	3,08	8	5,0	10
------------	--------	--	-----	----	---	------	---	-----	----

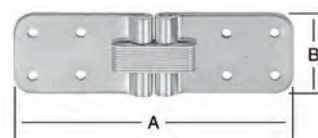

Geschlagene Klappenscharniere

Arretierung bei 180°



Leiterbänder

Ladder hinges
Charnières d'échelle
Bisagras para escaleras curvadas

Schulwandtafel-Scharniere

(Abb. ist rechts)

blau
verzinkt

001 = linke Ausf.
011 = rechte Ausf.

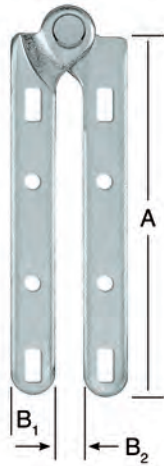

Artikel-Nr.	GTIN 4003984	Abmessungen mm			ca. kg je VE	Schrauben		verp. zu... Stck.
		A	B	Stärke		Stck.	Ø mm	
000019001Z	120029	150	16 10	4	8,33	4 rd. 4 ov.	4,0 4,0	50
000019011Z	120067	150	16 10	4	8,33	4 rd. 4 ov.	4,0 4,0	50

Schulwandtafel-Scharniere

(Abb. ist links)

blau
verzinkt

006 = linke Ausf.
016 = rechte Ausf.

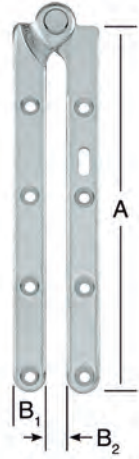

000019006Z	120432	205	18 12	5	15,20	8	5,0	50
000019016Z	120449	205	18 12	5	15,20	8	5,0	50

Gebogene Leiterbänder

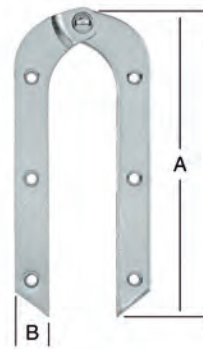

000032200Z	120111	200	21	4	2,86	6	5,0	10
------------	--------	-----	----	---	------	---	-----	----

Gebogene Leiterbänder mit Feststeller

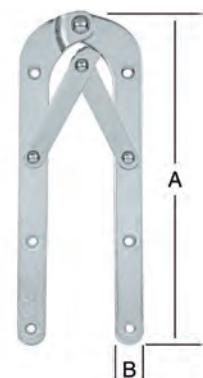

000033250Z	120142	250	21	4	4,02	6	5,0	10
------------	--------	-----	----	---	------	---	-----	----

Scharniere für Metallbau

Hinges for metal constructions
Charnières pour la construction métallique
Bisagras para construcción metálica

Seite
page
page
página



D



GB



F



E

Anschweißbänder
Bolzgelenkbänder

Weld-on hinges
Bar joint hinges

Pentures à souder
Charnières à broche

Bisagras para soldar
Bisagras articuladas con
perno

32-36
36

Edelstahl-Scharniere

Stainless steel hinges

Charnières en acier
inoxydable

Bisagras de acero
inoxidable

32-35

Nietgelenkbänder

Rivet joint hinges

Charnières rivées

Bisagras de remache
articuladas

36

Profilbänder

Profile hinges

Paumelles profilées

Bisagras de perfil

36

Stahlfensterscharniere

Steel window hinges

Charnière pour fenêtres
en acier

Bisagras pour ventanas
metálicas

34

Tischbänder

Flap hinges

Charnières de table

Bisagras alargadas

33

Ungebohrte Scharniere

Undrilled hinges

Charnières non alésées

Bisagras sin taladrar

32-36

Wagentürscharniere

Car door hinges

Charnières de portières
de voiture

Bisagras para puertas
de coche

36

Anschweißbänder / Ungebohrte Scharniere

Weld-on hinges / Undrilled hinges
 Pentures à souder / Charnières non alésées
 Bisagras para soldar / Bisagras sin taladrar

Gerollte schmale ungebohrte Scharniere DIN 7954 A...U mit vernietetem Eisenstift

mit vernietetem
Edelstahlstift

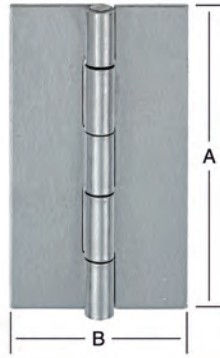

Artikel-Nr.	GTIN 4003984	Abmessungen mm			ca. kg je VE	Schrauben		verp. zu... Stck.
		A	B	Stärke		Stck.	Ø mm	
000401040U	010047	40	26	0,9	0,01	-	-	1
000401050U	010061	50	31	1,2	0,02	-	-	1
000401060U	010085	60	34	1,4	0,03	-	-	1
000401080U	010108	80	41	1,5	0,06	-	-	1
010501050U	020138	50	31	1,0	0,40	-	-	20



Gerollte halbbreite ungebohrte Scharniere DIN 7954 B...U mit vernietetem Eisenstift

mit vernietetem
Edelstahlstift

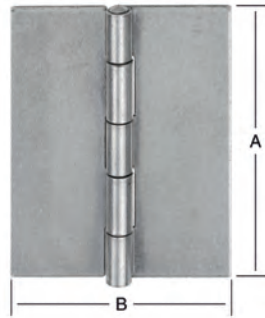

000402060U	010184	60	46	1,4	0,04	-	-	1
000402080U	010207	80	58	1,5	0,07	-	-	1
010502060U	020206	60	46	1,2	0,70	-	-	20



Gerollte ungebohrte kántige Scharniere DIN 7954 C...U mit vernietetem Eisenstift

mit vernietetem
Edelstahlstift

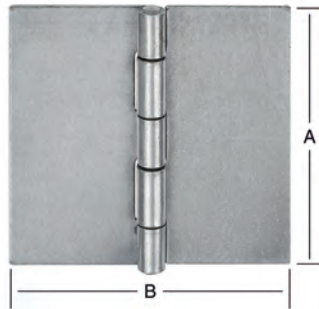
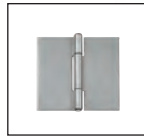

000403040U	010252	40	40	0,9	0,02	-	-	1
000403050U	010276	50	50	1,2	0,03	-	-	1
000403060U	010290	60	60	1,4	0,05	-	-	1
000403100U	010351	100	100	1,6	0,16	-	-	1
010503040U	020251	40	40	0,9	0,80	-	-	50



Gerollte ungebohrte breite Scharniere DIN 7954 D...U mit vernietetem Eisenstift

mit vernietetem
Edelstahlstift

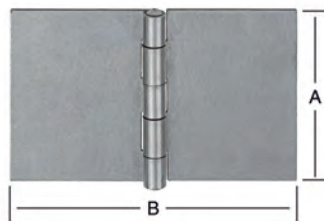
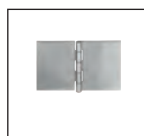

000404060U	010436	60	90	1,4	0,07	-	-	1
010504060U	020350	60	90	1,2	1,30	-	-	20



Artikel-Nr.	GTIN 4003984	Abmessungen mm			ca. kg je VE	Schrauben		verp. zu... Stck.
		A	B	Stärke		Stck.	Ø mm	

000405080U	010504	80	28	1,2	0,03	-	-	1
000405100U	010528	100	32	1,3	0,04	-	-	1
000405140U*	010559	140	34	1,6	0,05	-	-	1

010505100U 	020398	100	32	1,2	0,77	-	-	20
---	--------	-----	----	-----	------	---	---	----

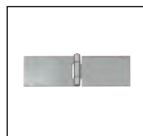

Anschweißbänder / Ungebohrte Scharniere

Weld-on hinges / Undrilled hinges
 Pentures à souder / Charnières non alésées
 Bisagras para soldar / Bisagras sin taladrar

**Gerollte
breite
ungebohrte
Tischbänder**
 DIN 7957...U
 mit vernietetem
Eisenstift

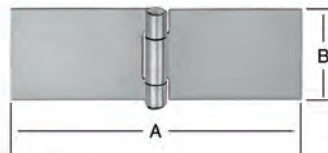

mit vernietetem
Edelstahlstift



*Auslaufartikel
discontinued

000506100U	011235	100	20	1,5	0,03	-	-	1
------------	--------	-----	----	-----	------	---	---	---

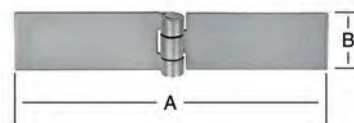

**Gerollte
schmale
ungebohrte
Tischbänder**
 mit vernietetem
Eisenstift



000217170U	080576	170	40	2,5	0,15	-	-	1
000217200U	080606	200	40	3,0	0,21	-	-	1

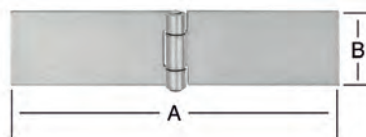

**Gerollte
starke
ungebohrte
Kistenbänder**
 mit vernietetem
Eisenstift



Anschweißbänder / Ungebohrte Scharniere

Weld-on hinges / Undrilled hinges
 Pentures à souder / Charnières non alésées
 Bisagras para soldar / Bisagras sin taladrar

Gerollte ungebohrte kältige Edelstahl-Scharniere
 mit durchgedrücktem Gewerbe
 mit vernietetem Edelstahlstift

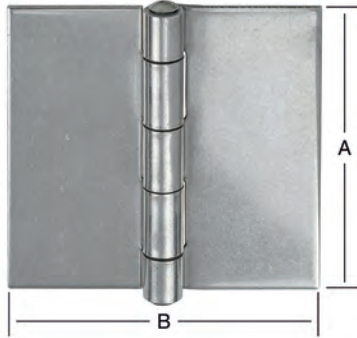

Artikel-Nr.	GTIN 4003984	Abmessungen mm			ca. kg je VE	Schrauben		verp. zu... Stck.
		A	B	Stärke		Stck.	Ø mm	
010613075U 	011372	75	75	1,75	2,76	-	-	24

Gerollte ungebohrte kältige Stahlfenster-Scharniere
 mit vernietetem Messingstift

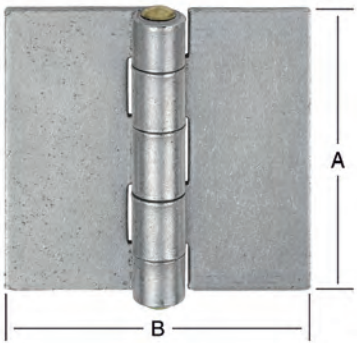

000653080VE	140126	80	80	3,0	4,30	-	-	20
-------------	--------	----	----	-----	------	---	---	----

Gerollte ungebohrte Stahlfenster-Scharniere
 DIN 18286 B

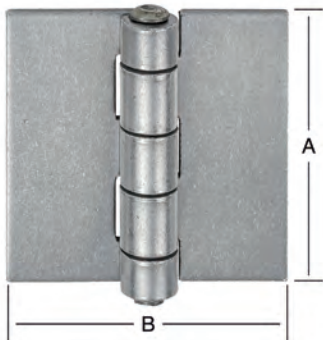

000650060EK	140041	60	55	2,5	2,09	-	-	20
000650060MK	140058	60	55	2,5	2,11	-	-	20
000650060VM	140065	60	55	2,5	2,11	-	-	20
000650095MK	140089	95	65	3,0	4,64	-	-	20

Artikel-Nr.	GTIN 4003984	Abmessungen mm			ca. kg je VE	Schrauben		verp. zu... Stck.
		A	B	Stärke		Stck.	Ø mm	
000614075U	011396	75	75	2,0	0,12	-	-	1
010614060U 010614075U	020589 020596	63 75	63 75	1,5 1,75	1,63 2,82	- -	- -	24 24



Anschweißbänder / Ungebohrte Scharniere

Weld-on hinges / Undrilled hinges
 Pentures à souder / Charnières non alésées
 Bisagras para soldar / Bisagras sin taladrar

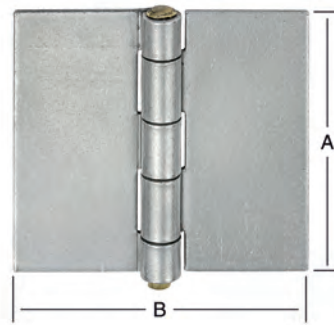

Gerollte breite ungebohrte kältige Scharniere
 mit durchgedrücktem Gewerbe
 mit losem Messing-Knopfstift

mit losem Edelstahl-Knopfstift



010870090U	020510	90	85	2,5	2,15	-	-	10
------------	--------	----	----	-----	------	---	---	----

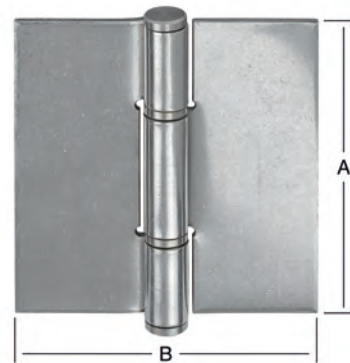

Gerollte ungebohrte Edelstahl Türscharniere
 mit durchgedrücktem Gewerbe
 mit festem Edelstahl-Zylinder-Stift und Edelstahl-Zwischenringen
 Oberfläche trowalisiert



011001080	020565	80	16	Ø 13,6	0,54	-	-	6
-----------	--------	----	----	--------	------	---	---	---



Profil-Edelstahl Anschweißbandrollen
 Oberfläche blank
 Stift-Ø 8 mm

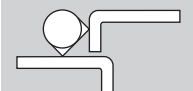

Anschweißbänder / Ungebohrte Scharniere

Weld-on hinges / Undrilled hinges
 Pentures à souder / Charnières non alésées
 Bisagras para soldar / Bisagras sin taladrar

Profil-Nietgelenkbänder

nach DIN 31211

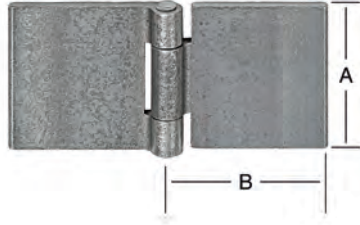
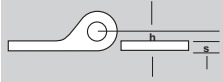

Artikel-Nr.	GTIN 4003984	Abmessungen mm			ca. kg je VE	Schrauben		verp. zu... Stck.
		A	B	Stärke		Stck.	Ø mm	
000014001NG	150187	40	20	s/h 3/4	0,50	-	-	10
000014005NG	150194	40	40	3/4	0,88	-	-	10
000014007NG	150217	60	30	5/6	1,74	-	-	10

Profil-Bolzen-Gelenkbänder

nach DIN 31211

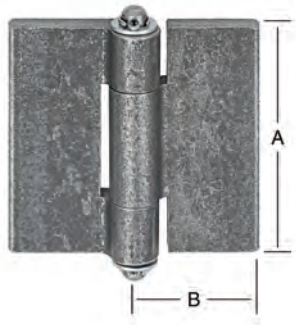
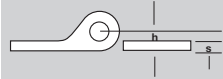

000014049BG	150231	80	40	s/h 7/8	4,18	-	-	10
-------------	--------	----	----	------------	------	---	---	----

Profil-Wagentürscharniere

Stift-Ø 4 mm

Stift-Ø 6 mm

Stift-Ø 8 mm

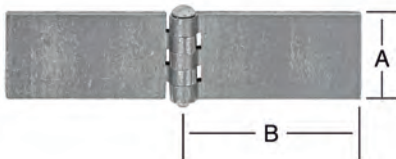

000012001	150019	30	40	3,0	0,66	-	-	10
000012004	150040	40	40	3,0	0,90	-	-	10
000012005	150057	50	40	3,0	1,14	-	-	10
000012003	150033	30	60	5,0	1,62	-	-	10
000012006	150064	40	30	5,0	1,18	-	-	10
000012007	150071	40	60	5,0	2,16	-	-	10
000012008	150088	40	80	5,0	2,85	-	-	10
000012009	150095	40	100	5,0	3,37	-	-	10
000012010	150101	50	60	5,0	2,66	-	-	10
000012011	150118	50	80	5,0	3,43	-	-	10
000012013	150132	60	60	5,0	3,17	-	-	10
000012014	150149	60	80	5,0	4,14	-	-	10
000012016	150156	60	80	6,0	4,93	-	-	10
000012017	150163	60	100	6,0	5,99	-	-	10
000012022	150170	80	80	6,0	6,50	-	-	10

Vormann bietet auch kundenindividuelle Sonderanfertigungen nach Zeichnung an.
Bitte senden Sie uns Ihre Anfrage mit Mengenangabe.

Vormann also offers customized productions according to drawing.
Please send us your inquiry with quantity.

Vormann peut aussi productions personnalisées à façon sur plans.
Merci de nous envoyer votre demande avec la quantité désirée.

Vormann ofrece también producciones personalizadas después del dibujo.
Por favor, envíenos su pregunta con la indicación de cantidades.

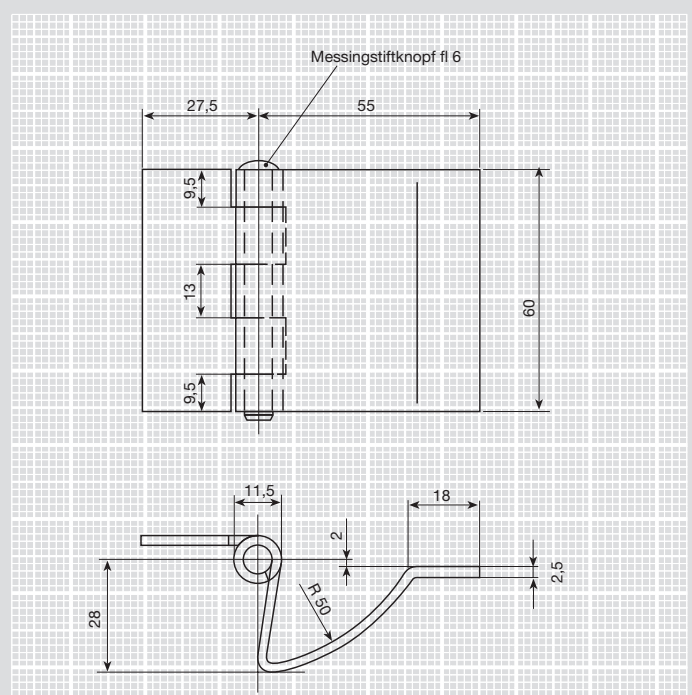
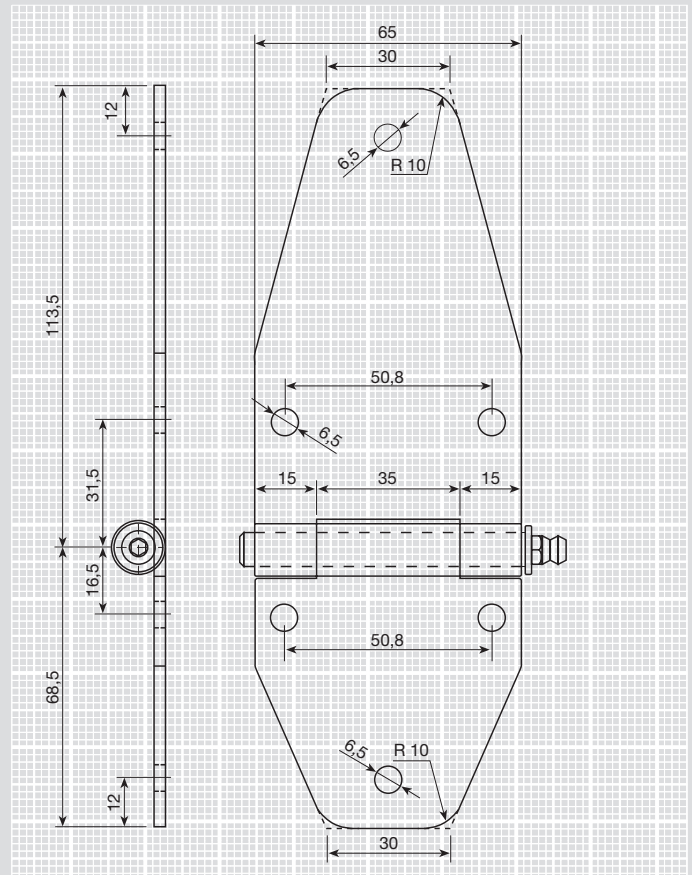
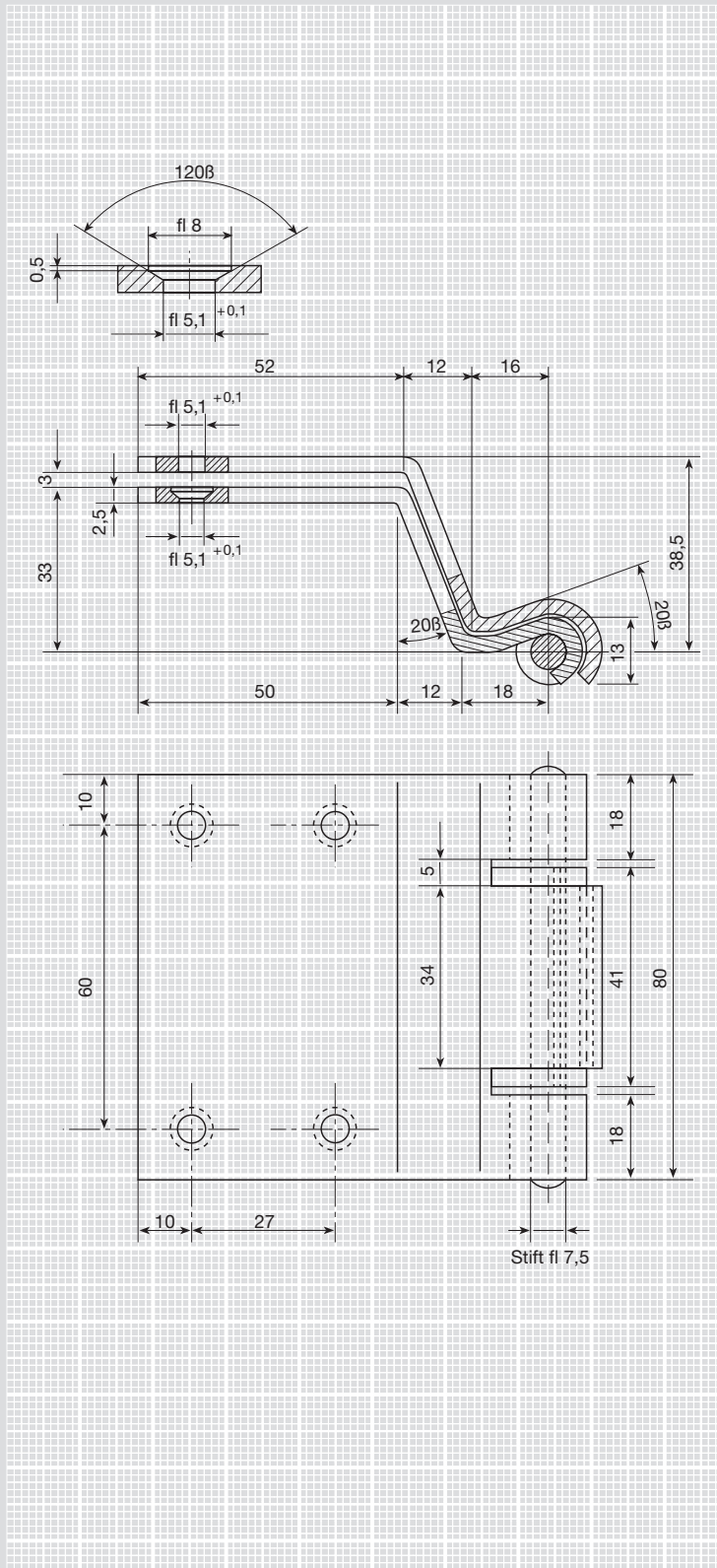



Werkzeugbau

Nach der Konstruktion auf modernen 3D CAD/CAM-Anlagen werden hier mit vorwiegend elektronisch gesteuerten CNC-Maschinen, Werkzeuge für den Bereich Stanz-, Zieh- und Biegetechnik sowie für die Scharnierfabrikation hergestellt

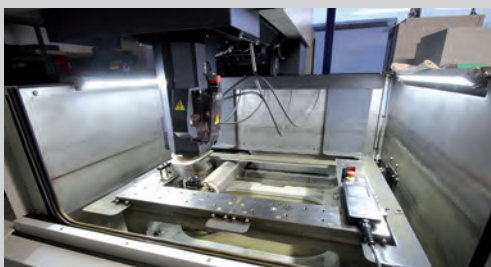

Toolmaker's shop

After the design on modern 3D CAD/CAM systems, tools for punching, drawing and bending technology as well as for hinge production are manufactured here using mainly electronically controlled CNC machines.

Fabrication des matrices

Après la construction sur des systèmes CAD/CAM 3D modernes, des outils pour le domaine de l'estampage, de l'emboutissage et du pliage ainsi que pour la fabrication de charnières sont fabriqués ici avec des machines CNC à commande largement électronique.

Fabricación de nuestros propios moldes

Después del diseño en los modernos sistemas CAD/CAM 3D, aquí se fabrican herramientas para el área de la tecnología de punzonado, dibujo y plegado, así como para la producción de bisagras, principalmente con máquinas CNC controladas electrónicamente.

Produktion

Beschlagfertigung: auf Hydraulikpressen (Druckleistung von 200–2.000 KN) und Stanzautomaten (Preßkraft von 400–4.000 KN)

Scharnierfertigung: auf Transfer-Vollautomaten sowie Roll-, Fräs-, Versenk-, Montier- und Nietwalzmaschinen.

Abmessungsbereich: von 0,7–8 mm Materialstärke von 20–1.000 mm Materialbreite aus Eisen und NE-Metallen sowie Chrom-Nickel-Stahl



Production

Production of fittings: hydraulic presses (power of 200–2.000 KN) and on automatic pressing machines (pressing power 400–4.000 KN).

Production of hinges: on fully automatic-transfer machines roll-milling-countersink-mount-and riveting rolling machines.

Measure-range: from 0,7–8 mm thickness from 20–1.000 mm breadth of iron and non-iron metals just as stainless steel

Fabrication

Fabrication des ferrures: presses hydrauliques (200–2.000 KN) et sur des automates d'estampage (pression de 400–4.000 KN).

Fabrication des charnières: sur des machines à 100% automatiques à rouler, à noyer, à assembler et des réveuses.

Nous travaillons du matériel: de 0,7–8 mm d'épaisseur de 20 à 1.000 mm de largeur en acier des métaux non ferrés ainsi qu'en acier niquel-chrome

Fabricación

Fabricación de accesorios: sobre prensas hidráulicas (presión de 200–2.000 KN) sobre máquinas automáticas de estampación (fuerza de 400–4.000 KN).

Fabricación de bisagras: sobre maquinaria automática.

Trabajamos aceros, metales no ferricos y acero níquel-cromo de 0,7–8 mm de grueso de 20–1.000 mm de anchura

Pulverbeschichtung in hoher Oberflächenqualität.

Modernste umweltverträgliche Verfahrenstechnik mit Teilvorbehandlung durch Entfetten und Phosphatieren.

Abmessungsbereich der Teile:

Tiefe 150 mm
Breite 1.000 mm
Höhe 1.000 mm
Alle RAL-Farben

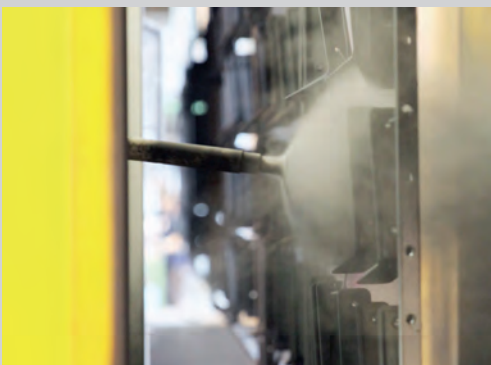

Powder coating

with a surface of high quality. Most modern and ecologically beneficial technique of production. The articles are removed from grease and phosphated before coated.

Sizes of the pieces: Depth: 150 mm Width: 1.000 mm Height: 1.000 mm All RAL-colours

Revêtement par poudre

en qualité de surface extraordinaire. Génie chimique la plus moderne, compatible à l'environnement avec conditionnement des pièces par dégraissage et phosphatage.

Dimensions des pièces: Profondeur: 150 mm Largeur: 1.000 mm Hauteur: 1.000 mm Toutes couleurs RAL

Revestimiento de plástico

en alta calidad. Modernas técnicas de procesamiento adaptados al medio ambiente con preparación de las piezas desgrase y fosfatación.

Dimensiones de las piezas: Profundidad: 150 mm Altura: 1.000 mm Ancho: 1.000 mm Todos los colores RAL

Lager und Versand:

Ein vollkommen integriertes und Barcode gesteuertes Hochregallagersystem mit etwa 5.600 Palettenplätzen erfüllt die logistischen Anforderungen einer anspruchsvollen Kundenschaft aus Handel und Industrie.



Storage and forwarding department

a fully integrated and barcode controlled high bay storage system with about 5.600 places for pallets, fulfils the logistical demands of pretentious customers out of trade industry.

Magasin et expédition

un système de stockage grande hauteur entièrement intégré et contrôlé par code barres avec place pour 5.600 palettes garantit de satisfaire les demandes d'une clientèle exigeante.

Almacen y expedición

un sistema de almacenamiento de estantería alta totalmente integrado y controlado por código de barras para 5.600 palettes permite a satisfacer las demandas de una clientela muy exigente.

Vertreter / Ansprechpartner Inland:

Michael Wolfs
 Nordstraße 32-34
 52353 Düren
 Tel.: 02421-7607843
 Mobil-Tel.: 0173-5455549
 m.wolfs@vormann.com

Edwin Benischke
 Inh. Alexander Løb e.K
 Grasiger Weg 11
 90518 Altdorf
 Tel.: 09187-959554
 Fax: 09187-808296
 Mobil-Tel.: 0172-9026677
 edwin.benischke@onlinehome.de

Dietmar Sarnes
 Aschhofen 16
 83620 Feldkirchen-Westerham
 Fax: 08063-2007128
 Mobil-Tel.: 0163-8312020
 dietmar.sarnes@web.de

Trudo Pfahl
 Werksvertretung
 Bachenauer Str. 15
 74254 Offenau
 Tel.: 07136-970380
 Fax: 07136-970382
 Mobil-Tel.: 0172-6688507
 trudo.ofahl.wv@t-online.de

WMS
 Jürgen Bürck
 Nachtigallenweg 30
 74855 Hassmersheim
 Tel.: 06266-7775
 Fax: 06266-7778
 Mobil-Tel.: 0171-5321156
 wms1jb@aol.com

Solibieda
 Vertriebs- und Service GmbH
 Höfkerstraße 27
 44149 Dortmund
 Tel.: 0231-9172230
 Fax: 0231-91722320
 solibieda@solibieda.de

Jörg Lang
 Zur Heide 19
 16348 Wandlitz
 Tel.: 0231-9172230
 Fax: 03222-1565100
 Mobil-Tel.: 0171-5154962
 joerg.lang@solibieda.de

Nur Fachhandel

 **Rosendahl & Koppel**
 Inh.: M. Petersen
 Bahnhofstr. 15
 21465 Reinbek bei Hamburg
 Tel.: 040/234147
 Fax: 040/233691
 Mobil-Tel.: 0171-8063050
 mark.petersen@roko-petersen.de

Karl Kregeler
 Werksvertretungen
 Herrendienstweg 71
 32120 Hiddenhausen
 Tel.: 05221-96900
 Fax: 05221-969030
 Mobil-Tel.: 0171-8547763
 info@kregeler-
 werksvertretungen.de

Rufen Sie uns an und wir nennen Ihnen Ihren zuständigen Außendienstmitarbeiter unter 0 23 33/978-0

Vertreter / Ansprechpartner Ausland:

Afrika
 August Vormann SA (PTY) LTD.
 P.O. Box 4545
 ZA 6539 George East
 Tel.: 0027-44-8781441
 Fax: 0027-44-8781408
 info@vormann.co.za

Belgien
 Husquin & Co SA
 Ikaroslaan 69
 B-1930 Nossegem-Zaventem
 Tel.: 0032-2-2620900
 Fax: 0032-2-2685241
 info@husquin.com

Dänemark
 Roliba A/S
 Hvidkaervej 52
 DK-5250 Odense
 Tel.: 0045-65930357
 Fax: 0045-65932757
 e-mail: post@roliba.dk

Estland
 HeWood OÜ
 Haapsalu mnt 21
 EE-76605 Keila, Harjumaa
 Tel.: 00372 53595155
 tellimine@hewood.ee

Frankreich
 Christophe Isoux
 ADF DIFFUSION
 1, rue de la Jaunaie
 F-35500 Vitre
 Tel.: 0033-256538305
 Mobil-Tel.: 0610137139
 Fax: 0033-253596055
 Email: adfisoux@aol.com

Griechenland
 Voyatzoglou Systems S.A.
 12 Km. Nat. Road Athens-Lamina
 GR-14451 Metamorfoosi-Athens
 Tel.: 0030-2102888600
 Fax: 0030-2102888699
 info@voyatzoglou.gr
 www.voyatzoglou.gr
 www.visitgreece.gr

Lettland
 SB & Partneri
 Renčenu iela 21 2.St.
 LV-1073, Riga
 Tel.: 00371-67113070
 info@sibunpartneri.lv

Niederlande
 Ruro Gereedsschappen B.V.
 Vestingdok 4
 NL-3433 KR Nieuwegein
 Tel.: 0031-30 608 42 42
 Fax: 0031-30 608 17 69
 info@ruro.nl
 www.ruro.nl

Österreich
 Christian Altenhofer
 Kokoschka Straße 31
 A-4020 Linz
 Tel.: 0043-6642147423
 ch.altenhofer@liwest.at

Pohl & Co GmbH & Co. KG
 Metallwarenerzeugung
 Zeller Str. 3
 A-4600 Wels
 Tel.: 0043-724246673
 Fax: 0043-724242160
 office@pohl.co.at

Polen
 Aspeo sp.z o.o.
 ul. Dąbrowskiego 97C/5
 PL - 60-574 Poznań
 Tel.: 0048-61-6463252
 Fax: 0048-61-6463258
 info@aspeo.pl
 www.aspeo.pl/pl

Rumänien
 EuroNarcis
 Str. Muresului nr. 1A
 RO-547526 Nazna, jud. Mures
 Tel.: 0040-265320013
 Fax 0040-265320083
 office@euronarcis.ro

Russland
 OOO "GTL" RUSSIA
 Yl.3-Sovetskay, de 11, lit A, pom 1H
 RUS-193015 St. Petersburg
 Tel.: 007-812-4599847
 Fax: 007-812-4599848
 manager.one@gtl.spb.ru

Schweiz
 SFS unimarket AG
 Rosenbergsaustrasse 4
 CH-9435 Heerbrugg
 Tel.: 0041-717275151
 Fax: 0041-717275499
 info@sfs.ch

Etter + Co. AG
 Espenmatt 1
 CH-9220 Bischofszell
 Tel.: 0041-714242121
 Fax: 0041-714242131
 mail: info@webi.ch

Slowenien
 Zeleznina Hudovernik d.o.o.
 Partizanska c. 2
 SLO-3320 Velenje
 Tel.: 00386-3898 23 50
 Fax: 00386-3898 23 60
 info@zeleznina.si

Tschechien
 Dastech s.r.o.
 Delnická 57
 CZ-41712 Proboštov
 Tel./Fax: 00420-417 532 894
 Mobil-Tel.: 00420-603 170 967
 dastech@seznam.cz
 www.dastech.cz

Jiří Dušek
 Porická 716/8
 CZ-198 00 Praha 9
 Mobil-Tel.: 00420-603 439 308
 jirha@seznam.cz

Ungarn
 Tamás Györe
 Cibkháza u. 78/1
 HU-1162 Budapest
 Tel.: 0036-704288228
 gyore.tamas@gmail.com



VORMANN
SCHARNIERE · BESCHLÄGE

August Vormann GmbH & Co. KG
Postfach 15 52
58244 Ennepetal

Heilenbecker Str. 191 -205
58256 Ennepetal
Deutschland / Germany

Telefon: ++49 (0) 2333 / 978 - 0
Telefax: ++49 (0) 2333 / 978 - 241599
www.vormann.com
E-Mail: info@vormann.com



Art-Nr. 089500051AV

